

FLIGHT DESIGN

CTLS

LSA

SERIAL NUMBER: _____

Aircraft Operating Instructions (AOI)

THIS DOCUMENT AND THE TECHNICAL DATA HEREON DISCLOSED ARE PROPRIETARY TO FLIGHT DESIGN AND SHALL NOT BE USED, RELEASED, OR DISCLOSED IN WHOLE OR IN PART WITHOUT EXPRESS WRITTEN PERMISSION FROM FLIGHT DESIGN



Aircraft Operating Instructions (AOI)

Type: *CT*

Series: *CTLS LSA*

Page: ii

REVISION STATUS

Rev	Pages	Date	Chapter	completed
1	All	Jan 08, 2008	All	OR / TP
2	61	Mar 03, 2008	7.4.6 Carbon monoxide detector added	Vasyl Sys
3	-	Apr 01, 2008	System of pages numbering changed.	
	-		Formatting (page breaks) partially changed	
	1-1		"All avionics and instruments recommendations in this document is for reference only." Added to item 1.1	
	1-3 – 1-4		Continued airworthiness instructions added as item 1.4	
	4-17		4.14 Autopilot control added	
	6-5		6.4 Equipment List updated	
	7-6 – 7-7		7.2.3 Fuel system updated	
	11-3		11.3 Safety of flight report form added	
4	4-7	Apr 29, 2008	4.5 Autopilot operation chapter moved from 4.14 to 4.5 and updated	Vasyl Sys
	7-7		Fuel system diagram corrected	
5	1-1	Jan 16 , 2009	1.1 Warning re-formatted and reworded	Oliver Reinhardt
	1-2		1.2 Manufacturer address corrected (house no.)	
	2-1		2.1. stall speed flaps -12° added; note added	
	2-3		2.5 Idle engine speed corrected	
	7-26		7.5 green arc limits for flaps -12° case added	
	9-1		9. Chapter reworded	
	10-1		10. Chapter reworded	
6	All	05 Feb 2009	Completely revision	Alexandra Lyashchenko
			Number of document changed. Numerical consistency of revision is continue from previous document – AU 010 11000 with 5 revision	
	2-1		Stall speed flaps -6° added; -12° - deleted	
	3-10		Flap's positions and corresponding data were changed	
	4-9		Flap's position -12° deleted in the picture	
	4-10		Changed to -6° only	
	4-12		Changed to -6° only	

AF 043 00005

Revision No. 6

Date: 05 Feb 2009



Aircraft Operating Instructions (AOI)

Type: *CT*

Series: *CTLS LSA*

Page: iii

REVISION STATUS

Rev	Pages	Date	Chapter	Completed
	4-15		Flap's position -12° deleted	
	4-16		Flap's position -12° deleted	
	7-16		Flap's position -12° deleted	
	7-26		Flap's position -12° deleted	
	7-27		Flap's position -12° deleted	
			Flap's position -12° deleted	
	6-1 – 6-10		Chapter 6 complete enhanced by weight and balance chart; equipment chapter in contents unchanged	
7	3-6	May 07, 2009	3.6 – information updated to match Junkers Magnum Rescue System	Oliver Reinhardt
	7-17 – 7-19		7.3.9 – Information updated to match Junkers Magnum Rescue System Attitude angle corrected to 13° 4th belt added in illustration with deployed system	
8	1-6	Aug 05, 2009	PowerFin propeller added	Oliver Reinhardt
	2-2		Flight load factor was changed from -1.5g to -2g	
	5-12 – 5-13		5.8 – Calculating the landing distance	
	7-5		PowerFin propeller added	



Aircraft Operating Instructions (AOI)

Type: *CT*

Series: *CTLS LSA*

Page: iv

LIST OF EFFECTIVE PAGES

CHAPTER			CHAPTER			CHAPTER			CHAPTER		
	PAGES			PAGES			PAGES			PAGES	
		REV			REV			REV			REV
1	1-1	5	4 (cont.)	4-8	4	6 (cont.)	6-7	6	7	7-26	6
	1-2	5		4-9	6		6-8	6		7-27	6
	1-3	4		4-10	6		6-9	6	8	8-1	4
	1-4	4		4-11	4	6-10	6	8-2		4	
	1-5	4		4-12	6	7	7-1	4		8-3	4
	1-6	8		4-13	6		7-2	4		8-4	4
	1-7	4		4-14	4	7-3	4	8-5		4	
2	2-1	6	4-15	6	7-4	4	8-6	4			
	2-2	8	4-16	6	7-5	8	8-7	4			
	2-3	5	4-17	4	7-6	4	9	9-1	5		
	2-4	4	5	5-1	4	7-7	4	10	10-1	5	
3	3-1	4		5-2	4	7-8	4	11	11-1	4	
	3-2	4		5-3	4	7-9	4		11-2	4	
	3-3	4		5-4	4	7-10	4		11-3	4	
	3-4	4		5-5	4	7-11	4				
	3-5	4		5-6	4	7-12	4				
	3-6	7		5-7	4	7-13	4				
	3-7	4		5-8	4	7-14	4				
	3-8	4		5-9	4	7-15	4				
	3-9	4		5-10	4	7-16	6				
	3-10	4		5-11	4	7-17	7				
	3-11	4	5-12	8	7-18	7					
4	4-1	4	5-13	8	7-19	7					
	4-2	4	6	6-1	6	7-20	4				
	4-3	4		6-2	4	7-21	4				
	4-4	4		6-3	4	7-22	4				
	4-5	4		6-4	6	7-23	4				
	4-6	4		6-5	6	7-24	4				
	4-7	4		6-6	6	7-25	4				



Aircraft Operating Instructions (AOI)

Type: *CT*

Series: *CTLS LSA*

Page: v

TABLE OF CONTENTS

1. GENERAL	1-1
1.1. INTRODUCTION.....	1-1
1.2. MANUFACTURER:.....	1-2
1.3. IN THE USA CONTACT	1-2
1.4. CONTINUED AIRWORTHINESS INSTRUCTIONS.....	1-3
1.5. THREE VIEW, MAIN DIMENSIONS:.....	1-5
1.6. ENGINE	1-6
1.7. PROPELLER.....	1-6
1.8. MINIMUM EQUIPMENT	1-7
1.9. RECOMMENDED ADDITIONAL EQUIPMENT	1-7
2. LIMITATIONS	2-1
2.1. AIRSPEED LIMITATIONS.....	2-1
2.2. FLIGHT LOAD FACTOR LIMITS.....	2-2
2.3. TIRE PRESSURE	2-2
2.4. MASS AND CENTER OF GRAVITY LIMITS:.....	2-2
2.5. POWER PLANT LIMITATIONS.....	2-3
2.6. OTHER LIMITATIONS.....	2-4
3. EMERGENCY PROCEDURES.....	3-1
3.1. EMERGENCY PROCEDURES CHECKLISTS	3-1
3.2. STALLS.....	3-3
3.3. INADVERTENT SPIN	3-3
3.4. EMERGENCY LANDING	3-4
3.5. AFTER OVERTURN ON LANDING.....	3-5
3.6. DEPLOYING THE BALLISTIC RECOVERY SYSTEM.....	3-6
3.7. ENGINE FAILURE	3-7
3.8. CARBURETOR OR ENGINE FIRE.....	3-8
3.9. LOSS OF COOLANT.....	3-9
3.10. LOSS OF OIL.....	3-9
3.11. FAILURE OF FLAP CONTROL.....	3-10
3.12. DYNON EMS FAILURE (IF INSTALLED).....	3-11
4. NORMAL PROCEDURES.....	4-1
4.1. NORMAL PROCEDURES CHECKLISTS.....	4-1
4.2. PREFLIGHT INSPECTION.....	4-5
4.3. PASSENGER BRIEFING	4-6
4.4. STARTING THE ENGINE	4-7
4.5. AUTOPILOT OPERATION	4-7
4.6. BEFORE TAKE-OFF.....	4-8
4.7. TYPICAL PATTERN.....	4-8
4.8. TAKE-OFF AND CLIMB.....	4-11
4.9. CRUISE.....	4-13
4.10. TURNS.....	4-14
4.11. STALL.....	4-15
4.12. APPROACH AND LANDING	4-15
4.13. SHUTTING DOWN THE ENGINE	4-17
4.14. CHECKING THE EMERGENCY LOCATION TRANSMITTER (ELT).....	4-17
5. PERFORMANCE	5-1
5.1. PERFORMANCE DATA FOR MTOW @ 600 KG (1320 LBS)	5-1
5.2. FLIGHT ALTITUDE AND DENSITY ALTITUDE.....	5-2
5.3. SIGNIFICANCE OF THE WIND COMPONENT.....	5-4



Aircraft Operating Instructions (AOI)

Type: *CT*

Series: *CTLS LSA*

Page: vi

5.4.	ENGINE PERFORMANCE SUBJECT TO ALTITUDE	5-6
5.5.	CALCULATING THE TAKE-OFF DISTANCE	5-7
5.6.	CALCULATING CLIMB PERFORMANCE	5-10
5.7.	GLIDING CHARACTERISTICS.....	5-11
5.8.	CALCULATING THE LANDING DISTANCE	5-12
6.	WEIGHT AND BALANCE, EQUIPMENT.....	6-1
6.1.	WEIGHT LIMITS	6-1
6.2.	WEIGHING	6-1
6.3.	FLIGHT MASS AND CENTER OF GRAVITY	6-4
6.4.	EQUIPMENT.....	6-9
7.	AIRPLANE AND SYSTEMS DESCRIPTION	7-1
7.1.	AIRFRAME	7-1
7.2.	SYSTEMS	7-4
7.3.	FLIGHT CONTROLS.....	7-12
7.4.	COCKPIT	7-20
7.5.	PLACARDS AND MARKINGS	7-26
8.	HANDLING, SERVICE, MAINTENANCE	8-1
8.1.	JACKING	8-1
8.2.	SECURING THE AIRCRAFT FOR ROAD TRANSPORTATION	8-2
8.3.	PARACHUTE RECOVERY SYSTEM MAINTENANCE.....	8-2
8.4.	CLEANING AND CARE	8-3
8.5.	MANDATORY AIRCRAFT INSPECTIONS	8-5
8.6.	REPAIRS TO THE AIRFRAME	8-6
8.7.	CONTROL SURFACE DEFLECTIONS	8-7
9.	SAILPLANE TOW.....	9-1
10.	BANNER TOW	10-1
11.	APPENDICES	11-1
11.1.	CURRENT WEIGHING REPORT	11-1
11.2.	CURRENT EQUIPMENT LIST	11-2
11.3.	SAFETY OF FLIGHT REPORT FORM	11-3



1. GENERAL

1.1. Introduction

Every pilot must familiarize him/herself with the specific characteristics of each Light Sport aircraft. This Aircraft Operating Handbook (AOI-POH) must be studied in detail before the first flight is undertaken with the aircraft. The same applies to the operating handbooks and manuals of the ballistic recovery system, the engine and all other equipment installed in the aircraft, such as the Dynon EFIS / EMS, etc. All avionics and instruments recommendations in this document is for reference only.

Engines of Light Sport aircraft are not Part 33 certified aviation engines. The flight route must thus be chosen to ensure that an emergency landing after engine failure can be undertaken without difficulty.

The CTLS may only be operated under visual flight rules (VFR). Due to the high cruise speed and the great range, pilots may encounter meteorologically critical weather conditions more often. Flying into IFR conditions without the necessary training is extremely dangerous. As the pilot in command, you are responsible for the safety of your passenger as well as for your own safety. You are also responsible for the safety of uninvolved third parties. Avoiding dangerous situations is a pilot's first duty.

Warning: Use only alkali-free products when cleaning your composite aircraft. For more information, refer to chapter 8 Handling, Service, Maintenance.



Aircraft Operating Instructions (AOI)

Type: *CT*

Series: *CTLS* LSA

Page: 1-2

1.2. Manufacturer:

Flight Design GmbH
Sielminger Str. 51
70771 L.-Echterdingen
Germany

1.3. In the USA contact

Flight Design USA
P.O. Box 325
South Woodstock, CT. 06267
860-963-7272
airworthiness@flightdesignUSA.com

**1.4. Continued Airworthiness Instructions**

Unlike other aircraft for which the FAA is responsible for the continued certification compliance, for Light Sport Aircraft, the burden of continued certification compliance rests on a cooperative effort between the manufacturer and the Owner/Operator of the aircraft. To this end, certain Manufacturer and Owner/Operator responsibilities are outlined in ASTM F 2295, Standard Practice for Continued Operational Safety Monitoring of a Light Sport Aircraft.

1.4.1. Manufacturer Responsibilities

In order to fulfill the manufacturer's responsibilities, Flight Design USA maintains an Operational Safety Monitoring System that provides for the following practices:

A. Operational Safety Monitoring, a system by which:

1. Safety of Flight and Service Difficulties are reported by the Owner/Operator.
2. Safety of Flight and Service Difficulty issues are received, tracked, and evaluated by Flight Design USA.

B. Continued Airworthiness Support, a system by which:

1. Flight Design USA issues Safety Directives (Notices of Corrective Action) directed towards correcting Safety of Flight and Service Difficulty issues.
2. The Owner/Operator obtains and verifies that they have the latest safety of flight information developed by the manufacturer.

C. Maintenance Instructions

Provided to the Owner/Operator and pertaining to 100 hour and annual condition inspections.

D. Continued Airworthiness Instructions

Provided to the Owner/Operator and pertaining to maintaining the certification compliance of their S-LSA

1.4.2. Owner/Operator Responsibilities and Instructions

F 2295 states that the Owner/Operator shall:

A. Read and comply with the maintenance and continued airworthiness information and instructions provided by the manufacturer.

These instructions are included in the Aircraft Operating Instructions, Maintenance and Inspection Procedures and Flight Supplement manuals.

B. Provide the manufacturer with current contact information where the manufacturer may send the Owner/Operator supplemental notification bulletins.

At the time of delivery, the Owner/Operator will provide the contact information to Flight Design USA or its representative. Contact information may be updated at any time by:

Writing to: Flight Design USA P.O. Box 325, South Woodstock, CT 06267

 FLIGHT DESIGN	Aircraft Operating Instructions (AOI)	
	Type: <i>CT</i>	Series: <i>CTLS LSA</i> Page: 1-4

Or email: airworthiness@flightdesignusa.com

C. Notify the Manufacturer of any Safety of Flight issue or any significant Service Difficulty issue upon discovery.

Safety of Flight report forms and Service Difficulty report forms can be found in the aircraft manuals and on the Operational Safety Monitoring page of the Flightdesignusa.com website

D. Comply with all manufacturer issued notices of corrective actions and for complying with all applicable FAA regulations in regard to maintaining the airworthiness of the LSA airplane.

Airworthiness information will be sent to the Owner/operator contact address of record. Airworthiness information can also be obtained from Safety section of the Flightdesignusa.com website.

E. The Owner/operator shall ensure that any needed corrective action be completed as specified in a notice or by the next scheduled annual inspection.

Important: Should an Owner/Operator not comply with any mandatory service requirement, the LSA shall be considered not in compliance with the applicable ASTM Standards, and may be subject to regulatory action by the FAA.

AF 043 00005	Revision No. 4	Date: 29 Apr 2008
--------------	----------------	-------------------

1.5. Three view, main dimensions:

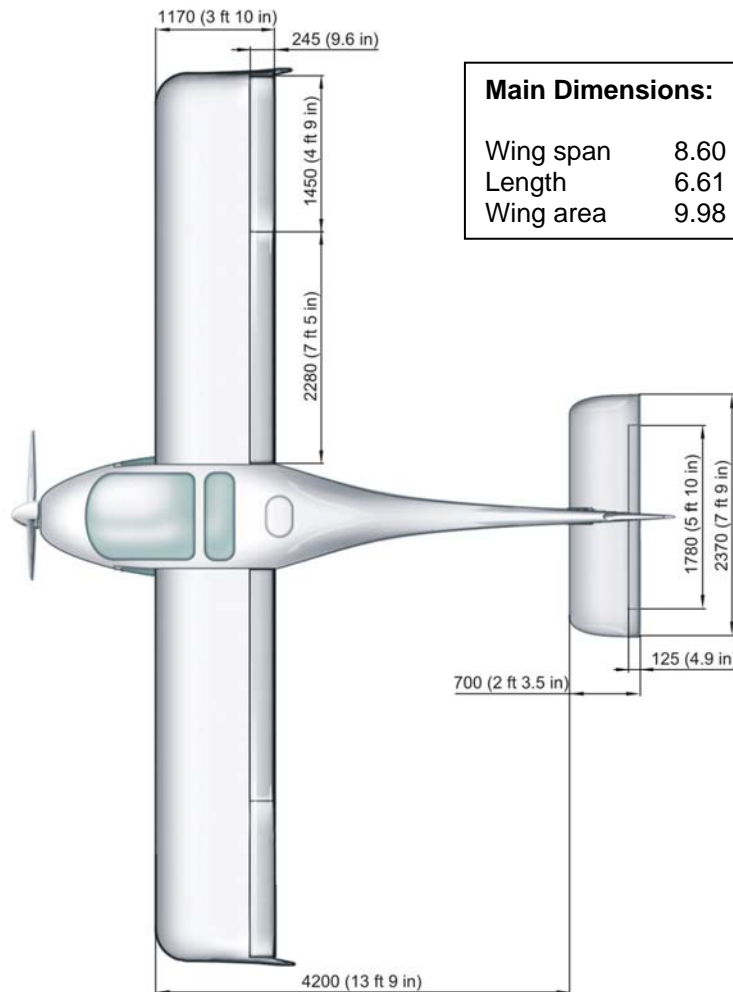
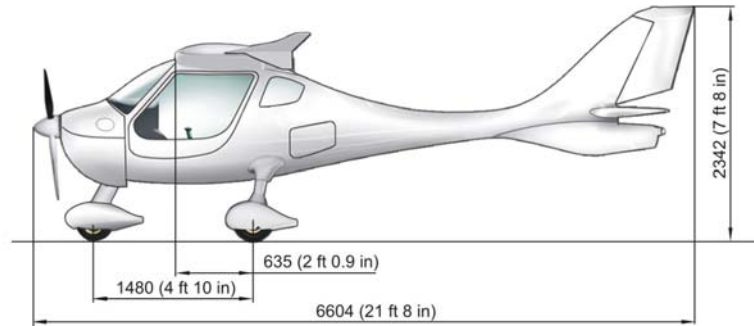

Main Dimensions:

Wing span	8.60 m (28 ft 2 in.)
Length	6.61 m (21 ft 8 in.)
Wing area	9.98 sq. m (107.4 sq-ft)

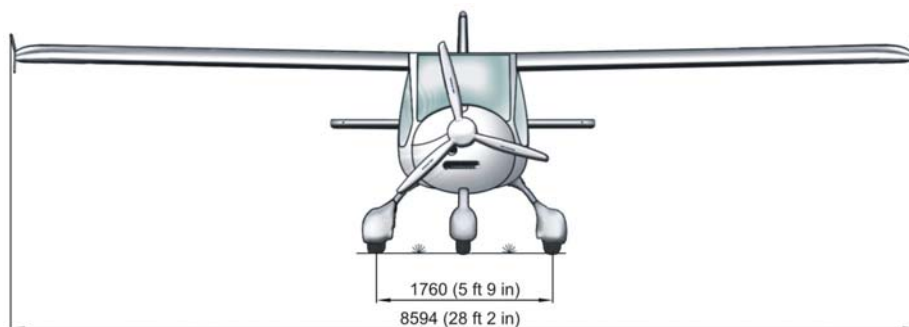

1.6. Engine

The CTLS is only available with the Rotax 912 ULS with 100 rated BHP. More detailed information on the engine is available from Rotax for your specific engine serial number.

Engine type:	horizontally opposed, four cylinder, four stroke engine
Cooling:	water-cooled cylinder heads
Horsepower rating and engine speed:	73.5 KW / 100 rated BHP at 5800 rpm
Carburetor type:	Bing constant pressure carburetor
Ignition:	electronically controlled dual ignition
Propeller gear reduction:	2.43 : 1

1.7. Propeller

Various types of propeller are available for the CTLS. Each propeller has its own operating handbook and maintenance manual published by the propeller manufacturer. These documents are delivered with the aircraft and must also be studied in detail. The following types of propeller have been certified for the CTLS:

Neuform	CR3-65-47-101.6, 3 blade, composite propeller, adjustable
Neuform	CR3-V-R2H, 1.70m diameter, 3 blade, hydraulically activated variable pitch, composite propeller
Kaspar- Brändel	KA1, 1.60 m diameter, 3 blade, variable pitch, composite propeller
PowerFin	A R 65 T, 1.65 m diameter, 3 blade, composite propeller, ground adjustable



Aircraft Operating Instructions (AOI)

Type: *CT*

Series: *CTLS LSA*

Page: 1-7

1.8. Minimum equipment

Airspeed indicator	up to at least 350 km/h (200 knots)
Altimeter	with Barometric window
Safety harness	four-point, one for each seat
Magnetic compass	with calibration card
Engine instruments	CHT, Oil Temp, Oil press, RPM.
Aircraft documents	national regulations apply

1.9. Recommended additional equipment

Ballistic recovery system	national regulations apply
Emergency locator transmitter (ELT)	mandatory in some countries
Radio	with intercom and headsets
Transponder	Mode C or S
External lighting	anti-collision light (ACL) and navigation lights, landing light



2. LIMITATIONS

2.1. Airspeed limitations

Stall speed	flaps -6°	v_{s1}	81 km/h	44 kts	CAS**
	flaps 0°	v_{s1}	75 km/h	42 kts	CAS
	flaps 35°	v_{s0}	65 km/h	39 kts	CAS
Maneuvering speed		v_a	184 km/h	98 kts	CAS
Maximum flap extended speed	flaps 0°	v_{fe}	184 km/h	100 kts	CAS
	flaps 15°	v_{fe}	148 km/h	80 kts	CAS
	flaps 30°, 35°	v_{fe}	115 km/h	62 kts	CAS
Maximum rough-air speed		v_{ra}	245 km/h	138 kts	CAS
Caution range			245 – 269 km/h	138 - 145 kts	CAS
Never-exceed speed (Vne)		v_{ne}	269 km/h	145 kts	CAS

* The never-exceed speed (VNE) demonstrated during flight testing is 301 km/h. However, VNE is limited by the maximum deployment speed for the ballistic recovery system or national regulatory requirements.

** The maximum negative flap setting is limited dependent from the country where the aircraft is registered, due to differences in national implementation of the LSA standards. So only one of the values for either -6° applies, dependent on the individual aircraft setting.

Maximum demonstrated crosswind	flaps 0°	30 km/h	16 kts
	flaps 35°	20 km/h	11 kts

Warning: Take-off and landing with crosswinds require a lot of training and experience. The greater the crosswind component, the more experience required.



2.2. Flight load factor limits

Maximum flight load factor	up to VA	+ 4g/ -2g
	up to VNE	+ 4g/ -2g

Warning: Up to $v_a = 184$ km/h (99 kts) (maneuvering speed) full control movements may be made.
Above v_a all control surfaces may only be deflected to a third of their maximum displacement.

Warning: Up to $v_{ra} = 245$ km/h (132 kts) IAS the CTLS can safely withstand a vertical gust of 15m/s (3000 fpm)
Above $v_{ra} = 245$ km/h (132 kts) IAS the CTLS can withstand the load of a vertical gust of 7.5 m/s (1500 fpm)

2.3. Tire pressure

Main landing gear tires	2 bar (28 psi)
Nose wheel tire	2 bar (28 psi)

2.4. Mass and center of gravity limits:

Minimum weight, solo pilot	54 kg (120 lbs)
Maximum mass per seat	118 kg (260 lbs)
Typical Empty weight, incl. recovery system *	310 kg (730 lbs)
Maximum take-off weight (MTOW)	600 kg (1320 lbs)

Baggage compartment 25 kg** (55 lbs) maximum on each side
50 kg** (110 lbs) maximum in total

Center of gravity range 282 – 478 mm*** (11.1 inches – 18.8 inches)

* Nominal empty weight with minimum equipment. The true empty weight depends greatly upon the equipment installed. The current weight of each aircraft is registered in the current weighing record. Refer to Chapter 6 "weight and Balance".

** Maximum values. The correct values for each aircraft may be calculated from the current weighing record. Refer to Chapter 6 "weight and Balance".

*** Reference datum is the wing leading edge with the aircraft in the neutral position. Refer to Chapter 6 "weight and Balance".

Warning: The weight data given are standard values. The correct data for each aircraft must be extracted from the current weighing record. Refer to Chapter 6 "Weight and Balance".



2.5. Power plant limitations

Maximum take-off power	73.5 kW	(100 HP)
	at 5800 rpm	(max 5 min)
Maximum continuous power	69 kW	(95 HP)
	at 5500 rpm	

Minimum take-off engine speed (fixed pitch propeller)

4800 rpm

Maximum continuous engine speed 5500 rpm

Idle engine speed approx. 1500 rpm

Cylinder head temperature, maximum * 120°C (248°F)

Oil temperature, minimum 50°C (120°F)

Oil temperature, maximum 140°C (248°F)

Recommended operating temperature 90 – 110°C (190°F - 230°F)

Oil pressure, normal operation 2.0 – 5.0 bar (29 – 73 psi)

Oil pressure, minimum 0.8 bar (12 psi)

Oil pressure, short-term maximum during extreme cold start conditions
7.0 bar (101 psi)

Oil grade brand automotive engine oils, no aviation oil - refer to the relevant ROTAX operating handbook for information on viscosity. Do not use oil additives.

Oil tank capacity 2.0 - 3.0 l (2.1 – 3.1 quarts)

Oil consumption, maximum .06 l/h (.06 q/h)

Fuel tank capacity: 130 l (34 gals)
2 wing tanks with 65 l (17 gallons) each

Usable fuel: 128 l (32 gallons)

Type of fuel: Premium Automotive unleaded per ASTM D 4814
Minimum AKI 91. For more complete information
Refer to the Rotax 912ULS Operators manual. Or
AVGAS 100 LL.

* Coolant temperature is monitored via the cylinder head temperature which is measured at the measuring point of the hottest cylinder

Warning: Due to its high lead content AVGAS has a detrimental effect on valve seating and causes greater deposition in the combustion chamber. It should thus only be used if fuel vapor or octane problems arise or if MOGAS is not available.



Aircraft Operating Instructions (AOI)

Type: *CT*

Series: *CTLS LSA*

Page: 2-4

Warning: When using AVGAS particular attention must be paid to type of oil used. For details refer to the valid version of the ROTAX engine manual.

Warning: The engine data given here is not complete. For complete information refer to the current version of the relevant engine manual from the Rotax company.

2.6. Other limitations

Warning: The aircraft is **not** certified for aerobatics!

The aircraft may only be operated during the day or night in visual flight conditions.

Flight into instrument meteorological conditions (IMC) is prohibited.

Flight into icing conditions is prohibited.

Turns steeper than 60 degrees of bank are prohibited.

Flight operations are not recommended during strong, gusty winds or wind speeds on the ground of more than 46 km/h (24kts-30 mph).

3. EMERGENCY PROCEDURES

3.1. *Emergency procedures checklists*

Emergency procedures are initially presented in the form of checklists. Amplified emergency procedures follow later in the chapter.

Even experienced pilots are strongly recommended to work with the checklists in the cockpit. It is the only way to ensure that in the distraction during flight important items are not overlooked.

The checklists are formulated so that they may be made into a small booklet which can be used in the cockpit. This booklet can be augmented with specific operational aspects should this be necessary.

The detailed procedures augment those points of the checklists which can only be explained in detail. It is important for safe operation that the pilot familiarize himself with these detailed procedures before starting flight operations.

<p>Spinning</p> <p>Controls neutral Rudder opposite direction of rotation Rotation stopped Throttle retard Elevator smooth recovery from dive</p> <p>Deploying the ballistic recovery system</p> <p>Ignition off Recovery system release Fuel shutoff valve off Emergency radio call transmit Master switch off Safety harness tight protective position taken</p> <p>Engine failure</p> <p>Below 300 Ft (100m) AGL make an emergency landing straight ahead Above 600 Ft (200m) AGL refer to procedures for restarting the engine</p>	<p>Restarting the engine</p> <p>Fuel shutoff valve open Fuel amount check Ignition both Propeller stopped ignition key to start Engine fails to restart make an emergency landing</p> <p>Emergency landing</p> <p>No suitable landing field deploy recovery system Landing field selected Safety harness tight Objects in cockpit securely stored Emergency radio call transmit Flaps as required Airspeed as required Flare 2' (50 cm) above ground or tree tops Ignition during flare off Fuel shutoff valve closed Elevator on touchdown tail low ELT automatic / as required</p>
---	---



Aircraft Operating Instructions (AOI)

Type: *CT*

Series: *CTLS LSA*

Page: 3-2

<p>Engine fire</p> <p>Fuel shutoff valve off Throttle full Ignition off Ignition key remove Flight attitude slip away from flames Landing make an emergency landing</p> <p>Loss of coolant</p> <p>Engine power reduce Cylinder head temperature below 150°C Landing as soon as possible at airfield</p> <p>Loss of oil</p> <p>Ignition off Ignition key remove Fuel shutoff valve off Landing make an emergency landing</p>		<p>Failure of flap control</p> <p>Alternator off Master switch off Master switch after 3 seconds to on Alternator on If everything okay end of procedure Flaps in cruise flight manually set to max. negative Long runway landing flap max. negative Short runway in short final, manually set to max. positive</p> <p>EMS failure</p> <p>Reduce airspeed 100 knots (185 km/h) with flaps negative</p>	
--	--	--	--



3.2. Stalls

The stall characteristics in level flight are docile. Normal flight attitude can be recovered by pushing the stick forward, increasing speed and then smoothly pulling the aircraft up again.

Maximum loss of altitude during stall recovery is 50m (165 ft). Pitch down does not exceed 25°.

The aircraft does not go into a spin during a stall in a 30° turn. Normal flight attitude can be recovered by pushing the stick forward, increasing speed and then smoothly pulling the aircraft up and simultaneously correcting the angle of bank.

Maximum loss of altitude during recovery is 60 m (180 ft). The angle of bank does not exceed 60°.

3.3. Inadvertent spin

The aircraft shows no inclination to go into an inadvertent spin during normal stall or during stalls in turns.

Should the aircraft, however, inadvertently enter into a spin, the following recovery procedure should be used:

- All control surfaces in neutral position
- Rudder opposite to direction of rotation
- Retard throttle
- Smooth recovery in the neutral attitude

Warning: As this aircraft is aerodynamically very efficient with low drag, airspeed increases quickly during a dive. It is essential that attention be paid to airspeed limitations, control surface deflection and flight load factors when recovering the aircraft from a steep dive.

Warning: Should the attempt to recover the aircraft fail or should recovery appear doubtful due to low altitude, the recovery system should be deployed.



3.4. *Emergency landing*

An emergency landing may be necessary for several different reasons. In addition to the loss of lubricants or the failure of aircraft systems, ominous weather conditions may also lead to an emergency landing.

In order to carry out an emergency landing, a suitable landing site must be found. It should be free of obstacles - including the approach - and should be long enough. The final approach to the site should be flown at the usual approach speed of 100 km/h (54kts).

The following points should be implemented during the approach:

Safety harness	lap belt tight, shoulders snug
Loose objects in the cockpit	securely stored
Radio signal	transmit to the appropriate ATC or to a nearby airfield so that the emergency services can be informed if necessary.

During a landing on unknown terrain it is recommended that the landing be accomplished at minimum safe speed and with the flaps set to 30° or 35°. The landing flare should be initiated at approx. 50 cm (2 ft) above the ground and the aircraft slowed down to minimum speed.

During flare it is recommended that the engine be shut down in order to reduce as far as possible the danger of a fire:

Ignition	off
Fuel shutoff valve	closed

On touchdown, the stick should be pulled back smoothly to prevent as far as possible overturning on landing caused by the nose wheel sinking into soft ground. Apply the brakes smoothly to bring the aircraft to a controlled stop.

During landings in cornfields, the tops of the trees or other crops should be seen as the landing surface. On short finals the flaps should be fully extended and airspeed should be 90 km/h (48 knots). The landing flare should be initiated at approx. 2 ft. (50 cm) above the assumed landing plain and the aircraft slowed down to minimum speed. On touchdown the stick should be pulled back smoothly to prevent as far as possible overturning on landing.

Warning: If urgent help is required after a forced landing, the ELT (if installed) can be activated manually thus alerting the search and rescue services.

Warning: Every CTLS is delivered with a fire extinguisher in a pocket on the back of the passenger seat. It can be used to fight small fires in the cockpit.

Should a forced landing not be possible and should the aircraft be at a sufficiently high altitude, the ballistic recovery system may be deployed. Refer to special emergency procedures for the deployment of the recovery system.



3.5. After overturn on landing

Due to its design, the CTLS offers good occupant protection during an overturn. Should you find yourself in this situation, brace yourself with your legs against the windshield. Unhook your safety harness. Be careful not to injure yourself on shards from the windshield or broken parts of the structure when you drop out of the seat. Evacuate the aircraft as quickly as possible.

Warning: Check for leaking fuel when evacuating the aircraft - acute fire hazard - the fuel system is not designed for the upside-down position.

Warning: If urgent help is required after an emergency landing, the ELT (if installed) can be activated manually thus alerting the search and rescue services.

Warning: Every CTLS is delivered with a fire extinguisher in a pocket on the back of the passenger seat. It can be used to fight small fires in the cockpit.

3.6. Deploying the ballistic recovery system

Refer to the operating handbook published by the manufacturer of the recovery system for operating details. The recovery system can be deployed in relatively low altitudes. If deployed at a low airspeed, the damage to the aircraft can be kept to a remarkable minimum. Due to the position in which the aircraft is suspended from the parachute, the pilot is as well protected as possible during the deployment of the recovery system.

For the deployment of the ballistic recovery system the manufacturer gives the following sequence of activities. The manufacturer's manual provides further details the pilot has to acknowledge prior to first flight with the aircraft.

Kill the engine (that the rotating prop does not damage the parachute) – deploy the parachute (to do this, pull the handle with force to the very end, until the rocket has started) – re-tighten your seat belts (that they give best protection at touchdown) – brace yourself (hands in the neck, arms to protect face and head).

The release lever is located in the centre console between the seats. In an emergency, the lever must be pulled forcefully forward to detent.

Warning: Read recovery system operation manual for mandatory information provided by the recovery system manufacturer.

Warning: Once the recovery system is activated, the pilot gives up all active control of the aircraft. There is no possibility to release the parachute and return to aerodynamic flight.

Warning: The activation of the rescue system depends on the situation and is in the pilot's decision. Once you decided to activate the rescue system do it at once and do not waste precious time. Before deployment, if possible, tighten lap belts tight, shoulder harnesses snug.

Warning: The rescue system requires a certain time – and therefore altitude – to be fully deployed. In an emergency where the pilot has no more control about the aircraft, the recovery system should be deployed regardless of altitude.

Warning: Maximum speed for deployment is 178 kts (276 km/h) IAS. Should the condition of the aircraft permit, aircraft speed should be reduced to below this value. If unavoidable, the recovery system can be deployed at a speed above the maximum. The parachute is attached to the aircraft at multiple hard points, so the chances of recovery are still good.

Warning: If urgent help is required after a landing using the recovery system, the ELT (if installed) can be activated manually thus alerting the search and rescue services.

Warning: Every CTLS is delivered with a fire extinguisher in a pocket on the back of the passenger seat. It can be used to fight small fires in the cockpit.



3.7. Engine failure

Warning: Do not attempt to restart the engine at altitudes below 100 m (300 ft)

Warning: Do not attempt to return to the airfield if engine failure occurs immediately after take-off below an altitude of 250 m (750 ft).

Warning: Due to the increased loss in altitude, turns should not be attempted at altitudes below 50 m (150 ft).

After an engine failure in flight, an engine restart should be attempted if altitude and time permits. The prerequisites for a successful restart should first be checked:

Fuel shutoff valve	open
Amount of fuel	fuel available in both wing tanks
Ignition	both

If the fuel level is low in both tanks and one of the fuel tanks appears to be empty, level the wings and make certain that the aircraft is not side slipping or holding the wing with the apparently empty tank higher. If the aircraft is level and one of the tank indicators shows fuel available make certain you keep that wing slightly higher to ensure fuel is being supplied to the engine.

If airspeed is so low that the propeller has stopped, the engine must be started in the same way as on the ground using the starter.

The Rotax 912 ULS engine ignition is only active once a certain minimum propeller rpm is achieved (above 1200 rpm). If the propeller is wind-milling, it may be that the propeller rpm is too low to restart the engine. In this case the starter must be used.

Warning: Restarting the engine requires the full attention of the pilot. The stress factor in the cockpit increases considerably and simple mistakes may be made by even the most experienced pilot. It is therefore imperative that you continue to fly the aircraft! Be careful of controlled flight into terrain and other hazards of distraction.

If the engine cannot be restarted or if altitude does not allow an attempt to restart, a controlled forced landing should be carried out.

The power-off emergency landing procedure is basically the same as an emergency landing with engine power. The best glide speed is 78 knots (140 km/h) at a flight mass of 1320 lbs (600 kg). The flaps should be set to 0°. The flaps should only be extended beyond 0° when it is assured that the landing field will be reached. If you arrive too high at the chosen field perform descending figure 8's keeping the landing site in view until the turn for final approach.

Warning: During a landing without engine power, the glide path cannot be extended. Due to flap effectiveness and side-slipping, the glide path can be shortened considerably. Choose a landing field that you can glide to with certainty.



3.8. *Carburetor or engine fire*

If a fire breaks out in the engine compartment, the fuel shutoff valve must be turned off immediately. Throttle to full open to allow the engine to use up the fuel in the system quickly. Turn the Ignition off and take out the ignition key to ensure that the ignition is not inadvertently turned. Check that the fuel shutoff valve is still completely closed. In the fully closed position the lever is covering the slot for the ignition key.

Descend as quickly as possible, holding the flames away from the aircraft by sideslipping and perform an emergency landing similar to that without engine power.

If the flames have been extinguished and an emergency landing cannot be performed without engine power, an attempt may be made to restart the engine - should it indeed restart, an emergency landing should be made immediately.

The deployment of the recovery system can be a good alternative.

If the aircraft has become uncontrollable during the fire or if an emergency landing cannot be performed, the recovery system should not be deployed at greater altitudes, i.e. descend to an altitude of approx. 200 m (600 ft) (make sure that the maximum deployment speed for the recovery system is not exceeded). The recovery system can then be deployed.

Evacuate the aircraft immediately after landing.

Warning: Every CTLS is delivered with a fire extinguisher in a pocket on the back of the passenger seat. It can be used to fight small fires in the cockpit.



3.9. Loss of coolant

A loss of engine coolant does not mean that a forced landing must be carried out immediately.

The coolant is used solely to cool the cylinder heads. The cylinders are air-cooled. As coolant temperature is only indirectly indicated via the cylinder head temperature of the hottest cylinder, engine temperature monitoring is still possible even after a total loss of coolant.

In the case of a loss of coolant, engine power should be reduced enough to ensure that the cylinder head temperature remains within normal operation limits (below 150°C - 302°F). If airspeed becomes too low, the flaps may be partially extended (0°-15°). The aircraft can then be flown to a suitable airfield without causing permanent damage to the engine.

If the temperature cannot be held within operating limits, one must decide whether one is prepared to risk damage to the engine in order to reach a suitable field for an emergency landing.

3.10. Loss of oil

A loss of oil is a very serious condition as the hot oil can easily ignite if it drops on to the hot exhaust system. An emergency landing performed to the procedures described above should be carried out as soon as possible.



3.11. Failure of flap control

The flap motor is activated by a controller which allows the preselection of the desired flap position. The flap position is indicated digitally.

In principle, the CTLS can be landed irrespective of flap position. However, with negative flaps, the stall speed is higher and the resulting landing distance longer. When in doubt, an alternate airfield with a longer runway should be chosen.

Recommended approach speed with flaps 0° is 100 km/h - 54 kts. With flaps -6° the recommended approach speed increases to 120 km/h – 64 kts.

Should the control unit fail (not the motor), the electronic control of the flap motor should be reset. This is achieved by switching the alternator switch and the master switch off and then on again. It is safe to do this in flight as engine ignition is independent from the aircraft's power supply. Should this not work, the flaps can be set manually by moving the flap selection lever past the detent, up or down.

To set the flaps to negative, the flap lever is moved past and above the -6° position. Once the desired setting has been reached, the lever is returned to the -6° position. The flaps remain in the set position.

To set the flaps to positive, the flap lever is moved past and below the +35° position. Once the desired setting has been reached, the lever is returned to the +35° position. The flaps remain in the set position.

Warning: If the lever is not returned from the manual position, the flap motor continues to run until the end position is reached.

Warning: As the flap position is no longer regulated by the controller, the pilot must ensure that airspeeds for flight with flaps extended are not above the limits shown on the flap lever placard.



Aircraft Operating Instructions (AOI)

Type: *CT*

Series: *CTLS* LSA

Page: 3-11

3.12. Dynon EMS failure (if installed)

Dynon EMS failure (if installed) does not automatically adversely affect flight safety. However, should the Dynon EMS fail completely, engine parameters can no longer be monitored by the pilot. In order to reduce the risk of damage to a minimum, the flight may be continued but engine speed should be kept moderate (185 km/h – 100 kts) cruise speed with negative flaps). Sailplane towing or banner towing should be stopped when this failure occurs.

4. NORMAL PROCEDURES

4.1. Normal procedures checklists

Normal procedures are initially presented in the form of checklists. Amplified normal procedures follow later in the chapter.

All pilots are strongly recommended to work with the checklists in the cockpit. It is the only way to ensure that in the distractions that may arise during flight important points are not overlooked.

The checklists are formulated so that they may be made into a small booklet which can be used easily in the cockpit. This booklet can be augmented with specific operational aspects including helpful local information.

The amplified procedures augment those points of the checklists which can only be explained in detail. Self-explanatory points will not be further dealt with. Both sources (checklists and amplified procedures) should be used during normal operation.

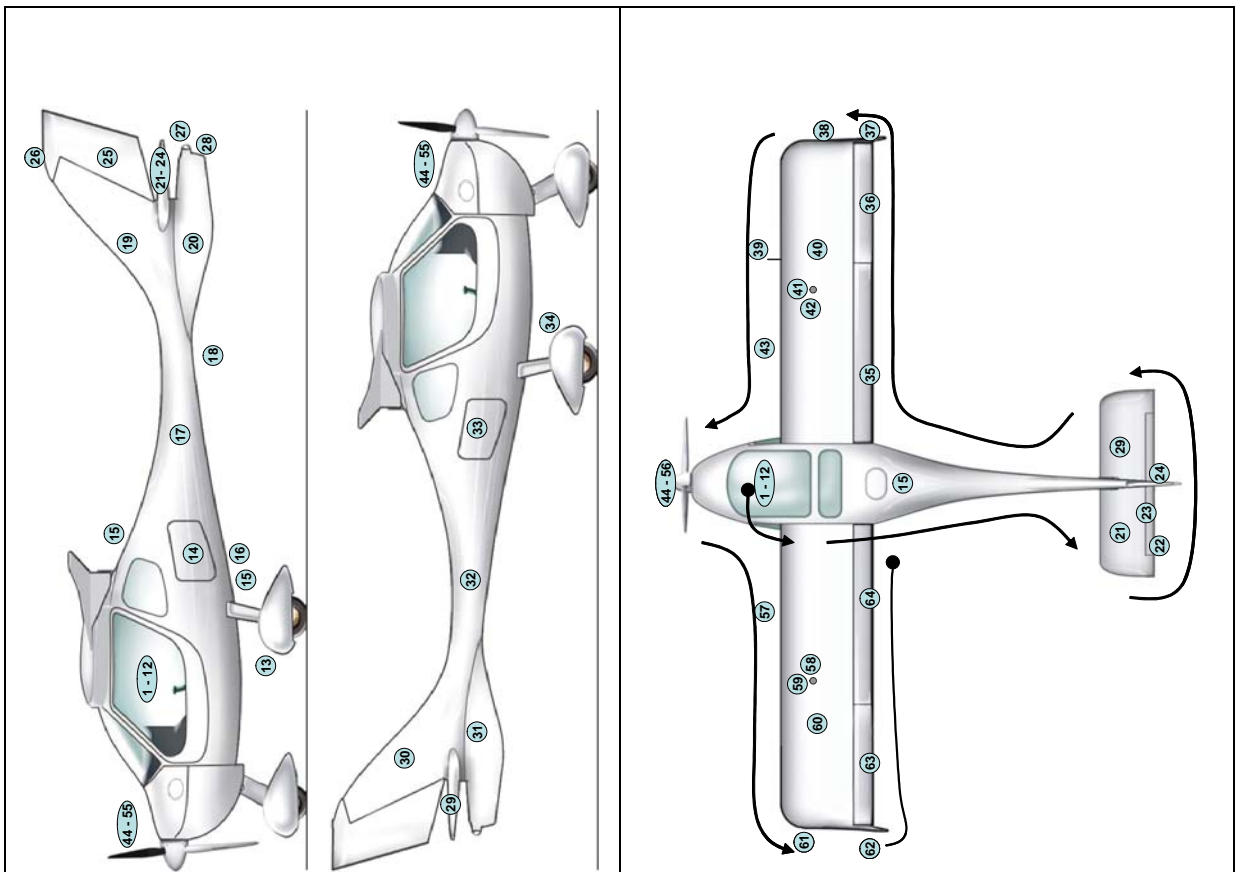



Aircraft Operating Instructions (AOI)

Type: *CT*

Series: *CTLS LSA*

Page: 4-2

<p>PREFLIGHT INSPECTION</p> <p>A. Cabin</p> <table style="width: 100%; border-collapse: collapse;"> <tr><td style="width: 30%;">1 Aircraft documents</td><td>on board</td></tr> <tr><td>2 Control surfaces</td><td>free and correct</td></tr> <tr><td>3 Main pins</td><td>inserted, caps in place and secured</td></tr> <tr><td>4 Ignition</td><td>off, key removed</td></tr> <tr><td>5 Electrical equipment</td><td>off</td></tr> <tr><td>6 Avionics switch</td><td>off</td></tr> <tr><td>7 Master switch</td><td>on</td></tr> <tr><td>8 Wing flaps</td><td>extended</td></tr> <tr><td>9 Master switch</td><td>off</td></tr> <tr><td>10 Fuel shutoff valve</td><td>open</td></tr> <tr><td>11 Doors</td><td>function checked</td></tr> <tr><td>12 Windows</td><td>check</td></tr> </table>	1 Aircraft documents	on board	2 Control surfaces	free and correct	3 Main pins	inserted, caps in place and secured	4 Ignition	off, key removed	5 Electrical equipment	off	6 Avionics switch	off	7 Master switch	on	8 Wing flaps	extended	9 Master switch	off	10 Fuel shutoff valve	open	11 Doors	function checked	12 Windows	check	<p>PREFLIGHT INSPECTION</p> <p>B. Left side of aircraft</p> <table style="width: 100%; border-collapse: collapse;"> <tr><td style="width: 30%;">13 Main landing gear, tire</td><td></td><td></td></tr> <tr><td style="padding-left: 20px;">Landing gear fairing</td><td>check</td><td></td></tr> <tr><td>14 Baggage compartment</td><td>locked</td><td></td></tr> <tr><td>15 Antennas</td><td>undamaged</td><td></td></tr> <tr><td>16 Static pressure source</td><td>check clear</td><td></td></tr> <tr><td>17 Fuselage</td><td>no damage</td><td></td></tr> <tr><td>18 Rear tie-down</td><td>remove</td><td></td></tr> <tr><td>19 Vertical stabilizer</td><td>check</td><td></td></tr> <tr><td>20 lower Fin</td><td>check</td><td></td></tr> <tr><td>21 Horizontal stabilizer</td><td>check</td><td></td></tr> <tr><td>22 Trim tab</td><td>check</td><td></td></tr> <tr><td>23 Elastic flap hinge</td><td>check</td><td></td></tr> <tr><td>24 Trim tab link</td><td>check</td><td></td></tr> <tr><td>25 Rudder</td><td>check cables, bolts</td><td></td></tr> <tr><td>26 Rudder ACL</td><td>check</td><td></td></tr> <tr><td>27 Tow release</td><td>check</td><td></td></tr> <tr><td>28 Tail navigation light</td><td>check</td><td></td></tr> </table>	13 Main landing gear, tire			Landing gear fairing	check		14 Baggage compartment	locked		15 Antennas	undamaged		16 Static pressure source	check clear		17 Fuselage	no damage		18 Rear tie-down	remove		19 Vertical stabilizer	check		20 lower Fin	check		21 Horizontal stabilizer	check		22 Trim tab	check		23 Elastic flap hinge	check		24 Trim tab link	check		25 Rudder	check cables, bolts		26 Rudder ACL	check		27 Tow release	check		28 Tail navigation light	check	
1 Aircraft documents	on board																																																																											
2 Control surfaces	free and correct																																																																											
3 Main pins	inserted, caps in place and secured																																																																											
4 Ignition	off, key removed																																																																											
5 Electrical equipment	off																																																																											
6 Avionics switch	off																																																																											
7 Master switch	on																																																																											
8 Wing flaps	extended																																																																											
9 Master switch	off																																																																											
10 Fuel shutoff valve	open																																																																											
11 Doors	function checked																																																																											
12 Windows	check																																																																											
13 Main landing gear, tire																																																																												
Landing gear fairing	check																																																																											
14 Baggage compartment	locked																																																																											
15 Antennas	undamaged																																																																											
16 Static pressure source	check clear																																																																											
17 Fuselage	no damage																																																																											
18 Rear tie-down	remove																																																																											
19 Vertical stabilizer	check																																																																											
20 lower Fin	check																																																																											
21 Horizontal stabilizer	check																																																																											
22 Trim tab	check																																																																											
23 Elastic flap hinge	check																																																																											
24 Trim tab link	check																																																																											
25 Rudder	check cables, bolts																																																																											
26 Rudder ACL	check																																																																											
27 Tow release	check																																																																											
28 Tail navigation light	check																																																																											
<p>PREFLIGHT INSPECTION</p> <p>C. Right side of aircraft</p> <table style="width: 100%; border-collapse: collapse;"> <tr><td style="width: 30%;">29 Horizontal tail</td><td>check</td></tr> <tr><td>30 Vertical stabilizer</td><td>check</td></tr> <tr><td>31 Fin</td><td>check</td></tr> <tr><td>32 Fuselage I</td><td>check</td></tr> <tr><td>33 Baggage compartment</td><td>locked</td></tr> <tr><td>34 Main landing gear and tire</td><td>check</td></tr> </table> <p>D. Right wing</p> <table style="width: 100%; border-collapse: collapse;"> <tr><td style="width: 30%;">35 Wing flap</td><td>check</td></tr> <tr><td>36 Aileron</td><td>check</td></tr> <tr><td>37 Winglet, wing tip</td><td>check, vent clear</td></tr> <tr><td>38 Navigation light</td><td>check</td></tr> <tr><td>39 Pitot probe</td><td>check</td></tr> <tr><td>40 Tie-down</td><td>remove</td></tr> <tr><td>41 Fuel quantity</td><td>check</td></tr> <tr><td>42 Filler cap</td><td>shut</td></tr> <tr><td>43 Wing leading edge</td><td>check</td></tr> </table>	29 Horizontal tail	check	30 Vertical stabilizer	check	31 Fin	check	32 Fuselage I	check	33 Baggage compartment	locked	34 Main landing gear and tire	check	35 Wing flap	check	36 Aileron	check	37 Winglet, wing tip	check, vent clear	38 Navigation light	check	39 Pitot probe	check	40 Tie-down	remove	41 Fuel quantity	check	42 Filler cap	shut	43 Wing leading edge	check	<p>PREFLIGHT INSPECTION</p> <p>E. Aircraft - Nose</p> <table style="width: 100%; border-collapse: collapse;"> <tr><td style="width: 30%;">44 Engine cowling</td><td>remove</td></tr> <tr><td>45 Exhaust system</td><td>check</td></tr> <tr><td>46 Nose gear</td><td>check</td></tr> <tr><td>47 Air inlet</td><td>check</td></tr> <tr><td>48 Fluid lines</td><td>check</td></tr> <tr><td>49 Electrical wiring</td><td>check</td></tr> <tr><td>50 Fuel</td><td>drain; no contamination</td></tr> <tr><td>51 Landing light</td><td>check</td></tr> <tr><td>52 Propeller</td><td>check</td></tr> <tr><td>53 Spinner</td><td>check</td></tr> <tr><td>54 Battery</td><td>check</td></tr> <tr><td>55 Oil quantity</td><td>check</td></tr> <tr><td>56 Coolant quantity</td><td>check</td></tr> </table> <p>F. Left wing</p> <table style="width: 100%; border-collapse: collapse;"> <tr><td style="width: 30%;">57 Wing leading edge</td><td>check</td></tr> <tr><td>58 Fuel quantity</td><td>check</td></tr> <tr><td>59 Filler cap</td><td>shut</td></tr> <tr><td>60 Tie-down</td><td>remove</td></tr> <tr><td>61 Navigation light</td><td>check</td></tr> <tr><td>62 Winglet, wing tip</td><td>check, vent clear</td></tr> <tr><td>63 Aileron</td><td>check</td></tr> <tr><td>64 Wing flap</td><td>check</td></tr> </table>	44 Engine cowling	remove	45 Exhaust system	check	46 Nose gear	check	47 Air inlet	check	48 Fluid lines	check	49 Electrical wiring	check	50 Fuel	drain; no contamination	51 Landing light	check	52 Propeller	check	53 Spinner	check	54 Battery	check	55 Oil quantity	check	56 Coolant quantity	check	57 Wing leading edge	check	58 Fuel quantity	check	59 Filler cap	shut	60 Tie-down	remove	61 Navigation light	check	62 Winglet, wing tip	check, vent clear	63 Aileron	check	64 Wing flap	check			
29 Horizontal tail	check																																																																											
30 Vertical stabilizer	check																																																																											
31 Fin	check																																																																											
32 Fuselage I	check																																																																											
33 Baggage compartment	locked																																																																											
34 Main landing gear and tire	check																																																																											
35 Wing flap	check																																																																											
36 Aileron	check																																																																											
37 Winglet, wing tip	check, vent clear																																																																											
38 Navigation light	check																																																																											
39 Pitot probe	check																																																																											
40 Tie-down	remove																																																																											
41 Fuel quantity	check																																																																											
42 Filler cap	shut																																																																											
43 Wing leading edge	check																																																																											
44 Engine cowling	remove																																																																											
45 Exhaust system	check																																																																											
46 Nose gear	check																																																																											
47 Air inlet	check																																																																											
48 Fluid lines	check																																																																											
49 Electrical wiring	check																																																																											
50 Fuel	drain; no contamination																																																																											
51 Landing light	check																																																																											
52 Propeller	check																																																																											
53 Spinner	check																																																																											
54 Battery	check																																																																											
55 Oil quantity	check																																																																											
56 Coolant quantity	check																																																																											
57 Wing leading edge	check																																																																											
58 Fuel quantity	check																																																																											
59 Filler cap	shut																																																																											
60 Tie-down	remove																																																																											
61 Navigation light	check																																																																											
62 Winglet, wing tip	check, vent clear																																																																											
63 Aileron	check																																																																											
64 Wing flap	check																																																																											



Aircraft Operating Instructions (AOI)

Type: *CT*

Series: *CTLS LSA*

Page: 4-3

<p>STARTING THE ENGINE</p> <p>Preflight inspection complete Parking brake set Carburetor heat off Circuit breakers all in Avionics off Master switch on ACL on Fuel shutoff valve on (up) Ignition key in Choke as required Throttle idle Propeller area clear Ignition key turn to start then release Choke adjust, then off (forward) Oil pressure check Alternator switch on Avionics switch on Wing flaps retract</p> <p>TAXIING</p> <p>Brakes check Steering check</p>	<p>BEFORE TAKE-OFF</p> <p>Parking brake set Safety harnesses lap tight, shoulders snug Doors shut Control surfaces free Altimeter set to field elevation Transponder on, standby Choke shut Carburetor heat off Throttle 4000 rpm Engine gauges check Magneto, left max. drop 300 rpm Magnetos, both check Magneto, right max. drop 300 rpm max. diff. 120 rpm Magnetos, both check Oil temperature min. 51°C (122°F) Alternator control lamp off Throttle idle Flaps set Pitch trim set (neutral for takeoff) Radios set Recovery system unlocked (pin out) ELT armed</p> <p style="text-align: right;">... continued ...</p>
<p>BEFORE TAKE-OFF (continued)</p> <p>Passenger briefing complete Approach & departure clear Parking brake release</p> <p>NORMAL TAKE-OFF</p> <p>Wing flaps 0° - 15° Carburetor heat off Throttle full Take-off rpm 4800 – 5000 rpm</p> <p>Best rate-of climb 120 km/h (67 kts) (flaps 15°) 132 km/h (73 kts) (flaps 0°) 140 km/h (78 kts) (flaps -6°)</p> <p>Best angle-of-climb 110 km/h (61 kts) (flaps 15°) 120 km/h (66 kts) (flaps 0°)</p> <p>SHORT FIELD TAKE-OFF</p> <p>Wing flaps 15° Parking brake set Choke shut Carburetor heat off Throttle full Parking brake release Rotation 75 km/h (42 kts) Acceleration 110 km/h (61 kts) Best angle of climb 110 km/h (61 kts)</p>	<p>CLIMB</p> <p>Wing flaps -6°, 0° Airspeed @ -6° and 600 kg (1320 lbs) for ... best rate-of-climb $v_y = 140$ km/h (78 kts) ... best angle-of-climb $v_x = 126$ km/h (70 kts) Rpm max. 5500 rpm</p> <p>CRUISE</p> <p>Throttle as required Engine parameters in the green</p> <p>DESCENT</p> <p>Carburetor heat as required Altimeter set to field barometric</p> <p>BEFORE LANDING</p> <p>Safety harnesses tight Airspeed 110 km/h (61 kts) Wing flaps 15° ... 35° Landing light as required</p>



Aircraft Operating Instructions (AOI)

Type: *CT*

Series: *CTLS LSA*

Page: 4-4

NORMAL LANDING

Approach airspeed	100 km/h (54 kts)
Flaps in finals	15° or 30° as required
Airspeed on final	100 km/h (54 kts)
Flare	smoothly, nose not too high
After touchdown	stick smoothly back to relieve nose wheel

AFTER LANDING

Throttle	idle
Brakes	as required
Carburetor heat	off
Landing light	off
Wing flaps	retract

GO-AROUND

Throttle	full
Carburetor heat	off
Wing flaps	15°
Airspeed	110 km/h
Rate of climb	confirm positive rate

SHUTTING DOWN THE ENGINE

Parking brake	set
Avionics	off
Electrical equipment	off
Alternator	off
Ignition	off
Master switch	off
Ignition key	remove
Recovery system	lock (pin in)
ELT	check off

Passenger briefing

Safety harness	instructed
Door lock	instructed
Recovery system	instructed
Fire extinguisher spray	instructed
ELT remote control	instructed

4.2. Preflight inspection

Even if the CTLS was operated within the last 24 hours, it is essential that the aircraft be thoroughly inspected before the first flight of each day. This also means removing the engine cowling.

Warning: The inadvertent start-up of the engine is dangerous! Always ensure that the ignition and master switch are off.

Inspection details are given in the Rotax engine operating handbook. This pilot's operating handbook can only deal with the more important points.

Oil quantity can only be checked after the propeller has been slowly cranked (always crank in the rotation direction of the propeller, never against the direction of rotation) until a gurgling noise is clearly heard. Only then has the measurable amount of oil been transported into the oil reservoir. The amount of oil must lie between the two limits on the oil dipstick - max. /min. - and should never be allowed to sink below the minimum level. Before undertaking an extended trip, make sure that the oil level lies at least midway between the two limits. Do not overfill the tank.

Warning: If leakage of operating liquids is discovered, the engine may not be started until the cause of the leakage has been rectified. This is particularly important in the case of oil and fuel leaks as both constitute a fire risk.

The various propellers which can be installed in the CTLS are made of light-weight composite materials. In comparison to propellers from the General Aviation sector, these propellers do not consist of a wooden core which has been covered with composite material. Should such a full-composite propeller be damaged, then the entire load-carrying structure is affected. The propeller can no longer be used and must be inspected by a qualified technician. The same applies to the spinner. It is subject to high loads which can cause the smallest damage to grow very quickly. If it is damaged it too may no longer be used. If necessary, the aircraft may however be flown to an aviation workshop without the spinner cap.

Should cracks appear in the finish, the cause should be sought immediately. Cracks in composite structures are often indication of damage to the underlying structure. A qualified technician often has the means to check the structure without first having to remove the finish.

During the inspection of the cockpit and the baggage compartment, particular attention should be paid to loose objects. Objects easily fall out of bags and/or pockets when leaving the aircraft. These objects can then shift during flight and interfere with the control surfaces.

When flying alone, the passenger seat safety harness should be pulled tight and locked. No loose objects should be on the passenger side as they are not accessible to the pilot during flight.

Warning: The passenger seat is not intended for the transport of objects or bags. However, should objects (e.g. bags) be placed on the passenger seat,

	Aircraft Operating Instructions (AOI)	
	Type: <i>CT</i>	Series: <i>CTLS LSA</i> Page: 4-6

they must be secured so that they cannot shift even if the aircraft experiences strong vertical gusts and accelerations.

4.3. Passenger briefing

Before take-off, passengers should be briefed on the emergency procedures. This ensures that in an emergency passengers will act properly and not become a further problem for the pilot.

Even although one can confidently assume that these circumstances may never happen, it is important that they be discussed calmly on the ground. In this way, one can be sure that if it comes to it, the passenger will react correctly. The briefing should include at the least the following points.

Passengers should be briefed on the proper use of the safety harness - how it is worn, locked, tightened and opened. The safety harness is tightened first at the waist and then the shoulders in order to prevent the lap strap from riding up in a dangerous manner. The safety harness should be held tight at all times as light aircraft such as the CTLS can experience turbulence at any time during flight.

The door latching mechanism should be demonstrated. Particular emphasis should be placed on the fact that the doors must be pulled firmly against the door seals before locking the doors in order to prevent the latches from jamming.

Deployment of the recovery system should be explained. Passengers must be told of the importance of the handle in the middle console and how to operate it. In the unlikely event that the pilot is incapacitated, this information is very important.

Warning: Even if the passenger is an experienced General Aviation pilot, he/she should be briefed on the peculiarities of Light Sport aircraft. This is especially the case with respect to the parachute recovery system as these are usually not installed in GA aircraft.

A fire extinguisher spray is provided in a pocket on the back of the passenger seat. It can be used to extinguish small fires in the cockpit. This may be necessary after an emergency landing. Briefing passengers accordingly on the use of the fire extinguisher spray is very important.

If immediate help is required after an emergency landing, the ELT (if installed) can be activated using the remote control in the lower central panel. If the pilot is no longer capable of acting, the passenger should know how he can activate the unit. This information is very important.

AF 043 00005	Revision No. 4	Date: 29 Apr 2008
--------------	----------------	-------------------

4.4. *Starting the engine*

The fuel shutoff valve is positioned so that it impedes the turning of the ignition key so that it is virtually impossible to forget it completely. However, before starting the engine one should make sure that the valve is completely open as only then is the supply of sufficient fuel to the engine guaranteed.

Before starting the engine, it should be cranked manually in the direction of rotation to prevent a hydraulic lock and thus damage to the engine. The safety regulations given in the engine operating handbook must be followed.

Warning: When starting the engine, the pilot's attention is directed to inside the cockpit. The parking brake should thus be applied to prevent the aircraft from moving. Should the aircraft, despite parking brake, start to taxi after the engine has been started, the engine must be cut immediately by turning off the ignition. The aircraft has a tendency to move with the engine in idle when on concrete or if a tail wind prevails.

To start the engine, the starter should be activated for a maximum of 10 seconds. This prevents over-heating and a continuous over-loading of the battery. A cool down period lasting two minutes is recommended between attempts at starting.

Pull the choke out completely and keep it fully open for about 20 - 30 seconds after the engine starts to turn, then slowly push shut. Adjust the throttle as required. The throttle must be closed (full aft on lever) during choke operation for mixture enrichment to function.

Since the engine has a propeller gearbox, start-up impact loads should be avoided. When starting the engine the throttle should not be more than 10% open. Once the engine starts to turn, the throttle should be adjusted to ensure that the engine runs smoothly. This is usually the case at engine rpm between 2000 and 2500 rpm.

Warning: Oil pressure must begin to show at the latest 10 seconds after the engine has started to turn. If this is not the case, the engine must be cut immediately. Engine rpm may only be increased once oil pressure exceeds 2 bar (28 psi).

Allow the engine to warm up at medium rpm. We recommend 2 minutes at 2000 rpm and then increase to 2500 rpm. The engine is ready for operation when the oil temperature has reached 50°C (122°F).

4.5. *Autopilot operation*

The autopilot master switch should be in the off position when the engine is started. After the engine is started, turn on the autopilot master switch and hold the aircraft stationary as the internal gyros are initialized. The model and software version will be displayed briefly. For approximately ten seconds afterward, the display will show the words PWR UP in the lower display. When initializing is complete PWR UP will change to AP OFF.

The autopilot can be turned on and off by pressing the control buttons on the Autopilot controller itself. The Autopilot can also be turned on and off using the white button on the control stick.

	Aircraft Operating Instructions (AOI)		
	Type: <i>CT</i>	Series: <i>CTLS LSA</i>	Page: 4-8

For more details regarding the Autopilot operation please take the time to look at the Autopilot manual.

Warning: Do not mistaken the autopilot button on the control stick with the Radio Transmit button. During the flight pay attention that you DO NOT press unintentionally white button on the control stick because it turns on and off the autopilot.

Warning: Normally the Autopilot is using your GPS Track as source for the course it tries to follow. In this case you see “TRK” in the upper half. When your plane holds wings level, but does not follow the selected route in your GPS, check if the Autopilot has lost the GPS signal. This can be clearly seen in the display, as the “TRK” display is gone and replaced by “NO GPS BANK”. In this backup mode the Autopilot tries to hold the wings according to the selected bank angle.

4.6. Before take-off

A flight should only be undertaken after a proper flight planning has been completed. Even if only pattern training is planned, you should first check if the runway length suffices under the prevailing conditions (surface conditions, wind, humidity, temperature).

The relevant checklist should be properly executed before each take-off. Small mistakes - such as the wrong flap setting - can lead to unanticipated developments during take-off and quickly lead to problems, for example on short runways with obstacles.

4.7. Typical pattern

The typical pattern can serve as a guidance for the suitable flight configuration during the various different phases of the pattern. In practice, it must, of course, be modified to take into account external influences, local circumstances or a compulsory pattern. Nevertheless you will be able to find the individual points again.

Following charts show two variants of traffic patterns. The big one is used when flying together with General Aviation Aircraft in the same pattern. In order to not slow them down flaps are retracted relatively early, and portions of the pattern are flown at good speed. The pattern is more roomy and fast. The small pattern can be flown on typical small light sport or private airstrips, and together with slower aircraft. As the CTLS is aerodynamically very efficient emphasis is laid upon keeping flaps set and speed controlled within the lower but safe limits. The pattern can be flown much more narrow this way, without generating pilot overload.

AF 043 00005	Revision No. 4	Date: 29 Apr 2008
--------------	----------------	-------------------

Typical Large Traffic Pattern CTLS

This pattern only serves as an example for a traffic pattern flown together with other General Aviation Aircraft. It has to be adapted to local circumstances (obstacles for example) and requirements (official traffic patterns for example).
 Provided data are for orientation only and do not replace Checklists or Procedures described in more detail within this manual.

In gusty conditions the given airspeeds have to be enhanced with suitable reserves.

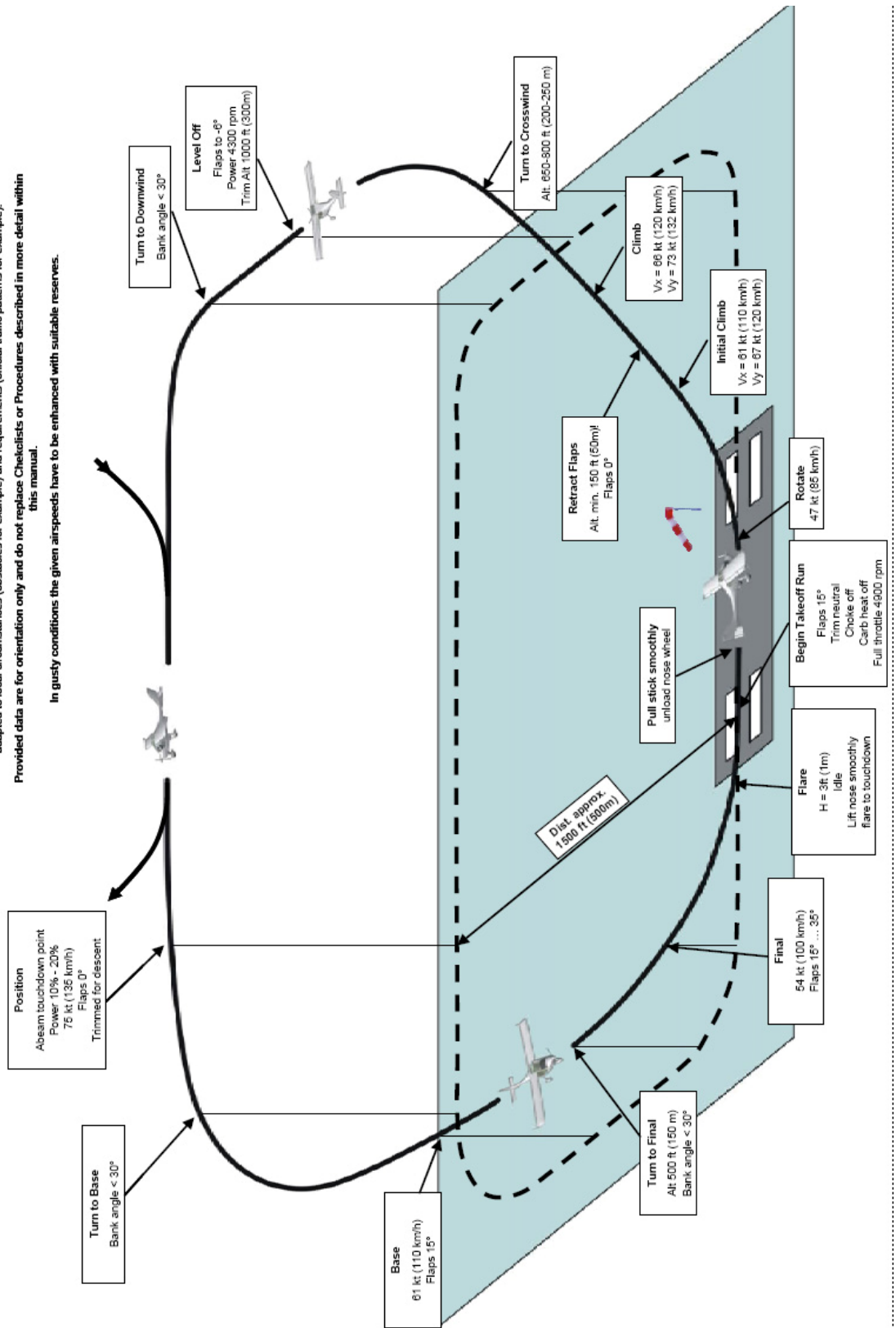

Typical Small Traffic Pattern CTLs

This pattern only serves as an example for a Light Sport traffic pattern. It has to be adapted to local circumstances (obstacles for example) and requirements (official traffic patterns for example). Provided data are for orientation only and do not replace Checklists or Procedures described in more detail within this manual.

In gusty conditions the given airspeeds have to be enhanced with suitable reserves.

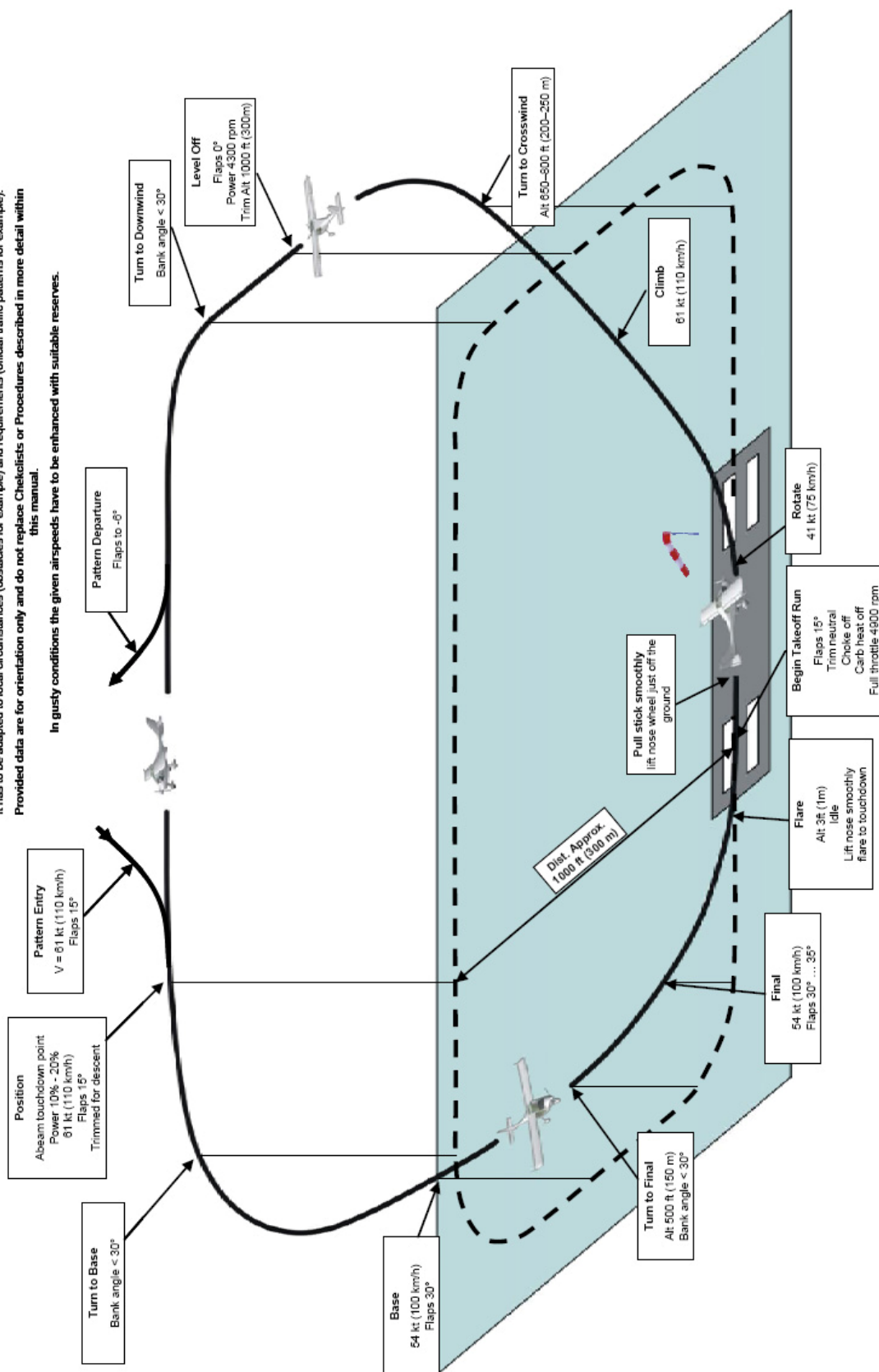

4.8. Take-off and climb

The airfoil of the CTLS offers good climb characteristics, even in the cruise-optimized flap position. Normally on short runways, the flaps are set to 15° for take-off. On hard surface runways, however, take-off is more efficient with the flaps set to 0°. This setting can also be used for a closed circuit as it reduces the pilot workload as the flaps need not be reset until abeam the touchdown point.

During the take-off roll, engine rpm should be checked after full throttle has been applied. Indicated engine rpm should be about 4800 rpm. Only when the engine has reached this speed is the correct take-off power available. These values are not valid for variable pitch propellers which leads to higher rpm for take-off which, in turn, results in better take-off performance.

In order to be able to hold direction on the runway, the CTLS pilot must look for an appropriate reference point. Pilots used to flying other types of aircraft are often confused by the strongly tapered fuselage nose of the CTLS, tending to take-off and land with a lot of sideslip. The pilot's view straight ahead is very much to the left. At first this appears to be far too far to the left, but it is indeed correct. The point can be located by drawing a vertical line upwards from the between the rudder pedals.



View from the pilot's seat, looking straight ahead.

As soon as the aircraft starts to accelerate, the stick should be pulled back slightly to unload the nose wheel. The aircraft takes off faster when the nose wheel is slightly lifted. When airborne, relax the aft pressure slightly to increase speed to best rate-of-climb speed (120 km/h – 67 kts with wing flaps +15°; 132 km/h – 73 kts with wing flaps 0°; both at takeoff weight of 1320 lbs – 600 kg).

Warning: Climbing at speeds below the recommended rate-of-climb speed does not bring any advantages as the aircraft will not climb as steeply when it is flying below the best angle-of-climb speed. With decreasing speed, the aircraft also becomes more difficult to control. These circumstances



Aircraft Operating Instructions (AOI)

Type: *CT*

Series: *CTLS LSA*

Page: 4-12

should be brought to mind when taking off from a short runway with obstacles.

Wing flap settings may be adjusted once a safe altitude of 50 m (150 ft) has been reached. The CTLS climbs at a better rate and a better angle with the flaps retracted to 0°. It is recommended that once an airspeed of 120 km/h (67 kts) is exceeded to retract the flaps from 15° to 0°. The climb can then be continued at 132 km/h (73 kts). When this speed is exceeded, the flaps can be further adjusted to -6°. The aircraft can then climb further and efficiently at 140 km/h (78 kts).

Warning: When adjusting the flaps to the negative position, the drag and lift coefficient of the airfoil are reduced for the same angle of incidence. The aircraft must thus be accelerated during flap retraction. As a result, climb rate drops initially before it then picks up again. When retracting the flaps in horizontal flight, the aircraft can sink slightly. Therefore, the flaps should never be moved in the negative direction near the ground!



4.9. Cruise

Normal cruise is performed with the flaps set at -6° . The airfoil offers the lowest drag in this setting and fuselage airflow is the most favorable. This is immediately apparent when the flaps are adjusted to this setting - the aircraft accelerates markedly.

The ground adjustable propeller installed in the CTLS is set by the manufacturer to ensure that maximum continuous power (5500 rpm) cannot be exceeded in horizontal cruise with full throttle. Despite this, attention should be paid to this limitation as climatic variations (temperature, air pressure) can lead to it being marginally exceeded.

Efficient cruise performance is achieved at about 4800 rpm. Greater rpm means greater airspeeds but this can only be achieved at the expense of much higher fuel consumption. The greatest range is achieved at the relatively low value of 4300 rpm.

The carburetor heat lever should be pulled out if there is a risk of carburetor icing. Once ice has accumulated it takes more than a few seconds for it to be removed. Carburetor heat must be left on for a long time. However, carburetor heat should not be kept on continuously as this leads to an enriching of the air/fuel mixture in the engine and can lead to fouling of the spark plugs which, in turn, adversely affects the smooth running of the engine and performance.

Warning: Never put on carburetor heat during take-off and climb as carburetor heat reduces engine performance.

During cruise, fuel consumption should be monitored closely. The Dynon EMS (if installed) shows current consumption, total consumption since take-off and remaining fuel quantity.

Warning: In order to achieve an accurate indication of fuel consumption using the Dynon EMS, the correct amount of fuel available must be programmed before take-off. Otherwise the values shown are not reliable. It is thus recommended that you do not rely on values programmed by someone else.

Fuel quantity should also be continuously monitored during flight by checking the fuel tank indicators in the wing roots. Despite their simplicity, they do give clear information about the fuel load in the tanks, particularly as fuel the level drops.

Warning: A correct indication on the fuel quantity tubes in the wing ribs is only possible when the wings are completely level.

Warning: There is a tendency to fly the CTLS with a small sideslip angle. Flight performance is only marginally affected but it can lead to the tanks emptying at different rates. In this case, it is recommended that the wing with the fuller tank be raised in a gentle slip temporarily. This can be achieved with the help of the rudder trim, if installed. The aircraft should be returned to level flight after a few minutes and the fuel indication checked. The amount in the tanks should now be more even.



Aircraft Operating Instructions (AOI)

Type: *CT*

Series: *CTLS LSA*

Page: 4-14

Warning: The tanks in the CTLS have return flow flapper valves on the fuel tank anti-sloshing rib (refer to Chapter 7 Systems description). They prevent fuel from quickly flowing into the outer tank area during side slipping where it could not be fed into the engine. The return flow valve reduces but does not completely prevent return flow. An exact indication of fuel quantity is thus only possible at the wing root when, after a sideslip, the aircraft has returned to normal flight attitude (and the amount of fuel inside and outside the anti-sloshing rib has evened out).

4.10. Turns

Each heading change is flown coordinated in the CTLS with aileron and rudder. The horizon is held level with the stabilizer. Maximum permissible airspeed (dependent upon the ballistic recovery system) should never be exceeded. Steep turns should not be flown, particularly at low altitudes.

At low speeds in tight turns the aircraft loses altitude rapidly. Turns with more than 30° bank should, therefore, not be flown below an airspeed of 100 km/h (54 kts). Should one of the wings drop and the aircraft go into a spin because of too low airspeed and crossed controls, it can be easily recovered. Refer to the relevant emergency procedures in Chapter 3.



4.11. Stall

Stalling speed for the CTLS with a weight of 600 kg (1320 lbs) is 72 km/h (39 kcas) with the flaps set at 35°, 77 km/h (42 kcas) with the flaps set at 0° and 81 km/h (44 kcas) with flaps set at -6°. Approaching stall is indicated by a sluggishness around the vertical axis. The controls become "soft" about 5 km/h (3 kts) above stall speed. Release the aft pressure on the stick to increase airspeed. Close to stall the aircraft can only be controlled by rudder and stabilizer. In a stall, the effectiveness of the ailerons is greatly reduced.

When the nose drops during a stall, the aircraft will lose approx. 50 m (165 ft) altitude. Thus, near the ground a safety minimum speed of approx. 115 km/h (62 kts) should be maintained.

4.12. Approach and landing

When possible, an aircraft should land into the wind. Final approach should be flown in a straight line extending in the direction of the runways and begun at sufficient altitude.

Warning: A stable final approach is important for a successful landing. If the landing configuration is taken up in good time and at a sufficiently high altitude, the pilot's work load may be reduced considerably. With the aircraft flying stably it can be more easily controlled down to touch-down. Too high approach speeds with flap changes shortly before touch-down lead very quickly to dynamic flight conditions which are very stressful for the pilot. If in doubt: abandon the approach and perform a go around. This is always better than taking a chance of damaging the aircraft due to a hard landing.

Some power (10 – 20 %) should be maintained during approach. This makes it easier to determine that the engine is running properly and is able to provide full power, if required. The slightly increased pressure on the empennage also has a positive effect on controllability and control feel.

If there is a risk of carburetor icing, the carburetor heat should be pulled on during the approach. It should, however, be pushed off in short finals so that full engine power is available, should a go-around be necessary.

Approach the ground with constant power setting. About a meter (3 ft) above the ground, retard the throttle completely and smoothly flare the aircraft.

A somewhat higher approach speed should be used for landings in a crosswind to ensure that the aircraft remains controllable. In addition, it is also recommended that the wing flaps be set at 15° or even 0° when landing in a crosswind. Be mentally prepared to perform a missed approach-go around if needed.

During a landing with crosswind, the upwind wing should be dipped by applying aileron against the wind and direction kept using the rudder. As the CTLS is a high-wing airplane, there is no risk of the wing tips touching the ground. .

Warning: Do not rely on the demonstrated wind speed data in the manual for crosswind landings. Local conditions can lead to lower limits. For



Aircraft Operating Instructions (AOI)

Type: *CT*

Series: *CTLS LSA*

Page: 4-16

example, hangars are often found at right angles to the touch-down point, causing dangerous leeward turbulence which cannot be avoided.

Warning: The aircraft can be landed with ease and safely with flaps set at 15°. A landing with flaps set at 0° or even -6° is possible. The maximum positive flap deflection (35°) should be used to land on very short runways (less than 1000ft) under favorable wind condition (no crosswind component, very light wind and low gusts). Landing with flaps set at 35° requires a lot of practice and should be trained with an experienced flight instructor familiar with the CTLS. The increased flap deflection does not reduce the attainable minimum speed, it does, however, greatly increase drag. This permits very short landings but can also create a rapid loss of speed during the landing flare. Flaring too high above the ground will cause the aircraft to drop. In this case, apply full power immediately for a go-around and a new approach. A go-around initiated with full flaps is not a problem for the CTLS. It is, however, recommended not to use full flaps when landing in a crosswind.

After landing, all unnecessary electrical equipment, especially the landing light, should be switched off. As this equipment requires a lot of power and since the alternator does not produce much power during taxiing due to relatively low engine rpm, the battery would discharge considerably before the engine is finally shut down.



4.13. Shutting down the engine

Under normal conditions, the engine cools sufficiently during descent and taxiing that it may be shut down by switching off the ignition. All electrical equipment along with the alternator should be switched off before the engine is shut down in order to protect the equipment from damage caused by a voltage spike. The Dynon EFIS and the Garmin 496 have back-up batteries which are activated if the aircraft power system fails or is switched off. These instruments are, therefore, still active when the power supply is switched off. Since they are independent from the aircraft power system, no damage can occur when the engine is shut down.

4.14. Checking the emergency location transmitter (ELT)

After every landing and, especially, after parking the aircraft, the ELT should be checked for accidental deployment. Under certain unfavorable circumstances, a hard landing can result in the activation of the ELT. It has also been known for the ELT to be switched on accidentally by hand during loading or unloading.

A false alarm can be simply detected by listening to the international emergency frequency 121.5 MHz on the COM radio. An active ELT is also shown on the remote control unit in the lower instrument panel.

5. PERFORMANCE

Performance data is based on an aircraft in good condition and correct settings. Even the smallest adjustments to the controls or the omission of a small piece of fairing can adversely affect aircraft performance. Sufficient reserve should be added to the data given in this handbook to cover all such possibilities.

5.1. Performance data for MTOW @ 600 kg (1320 lbs)

Take-off roll	flaps 15°	250 m	(820 ft)
Take-off distance to clear 50ft obstacle	flaps 15°	450 m	(1500 ft)
		Mowed, level, dry grass runway or pavement (It does not make a noticeable difference on this aircraft)	
Take-off speed	flaps 15°	85 km/h	(47 kts CAS)
	flaps 0°	100 km/h	(54 kts CAS)
Best rate-of-climb	flaps 15°	120 km/h	(62 kts CAS)
		3.7 m/s	(740 ft/min)
	flaps 0°	132 km/h	(73 kts CAS)
		4.0 m/s	(800 ft/min)
	flaps -6°	140 km/h	(78 kts CAS)
		3.8 m/s	(770 ft/min)
Best angle-of-climb	flaps 15°	110 km/h	(61 kts CAS)
		approx. 8:1	
	flaps 0°	120 km/h	(66 kts CAS)
		approx. 8:1	
Maximum level speed v_H	flaps -6°	222 km/h	(120 kts CAS)
		@ 5500 rpm	
Maximum range		1540 km	(830 NM)
		180 km/h IAS	(97 kts CAS)
		flaps -6°; @ 4300 rpm	

Warning: All performance data are based on standard atmosphere at sea-level and the Neuforn CR3-65-47-101. 6 propeller. They are also based on the procedures described in this handbook. Higher runway elevations, higher temperatures and other propellers can lead to considerable differences in the data!

5.2. Flight altitude and density altitude

In order to determine exactly the aircraft performance available for a particular flight, the density altitude must be calculated. The CTLS is equipped with a carbureted engine, the performance of which varies according to ambient temperature and pressure. This is the reason that density altitude is so important. The aerodynamic characteristics of the aircraft are also dependent upon this parameter.

Density altitudes can easily be calculated using the following table. Using this density altitude as the input parameter, the performance which can truly be expected will be calculated in the following sections.

Density Altitude [ft]

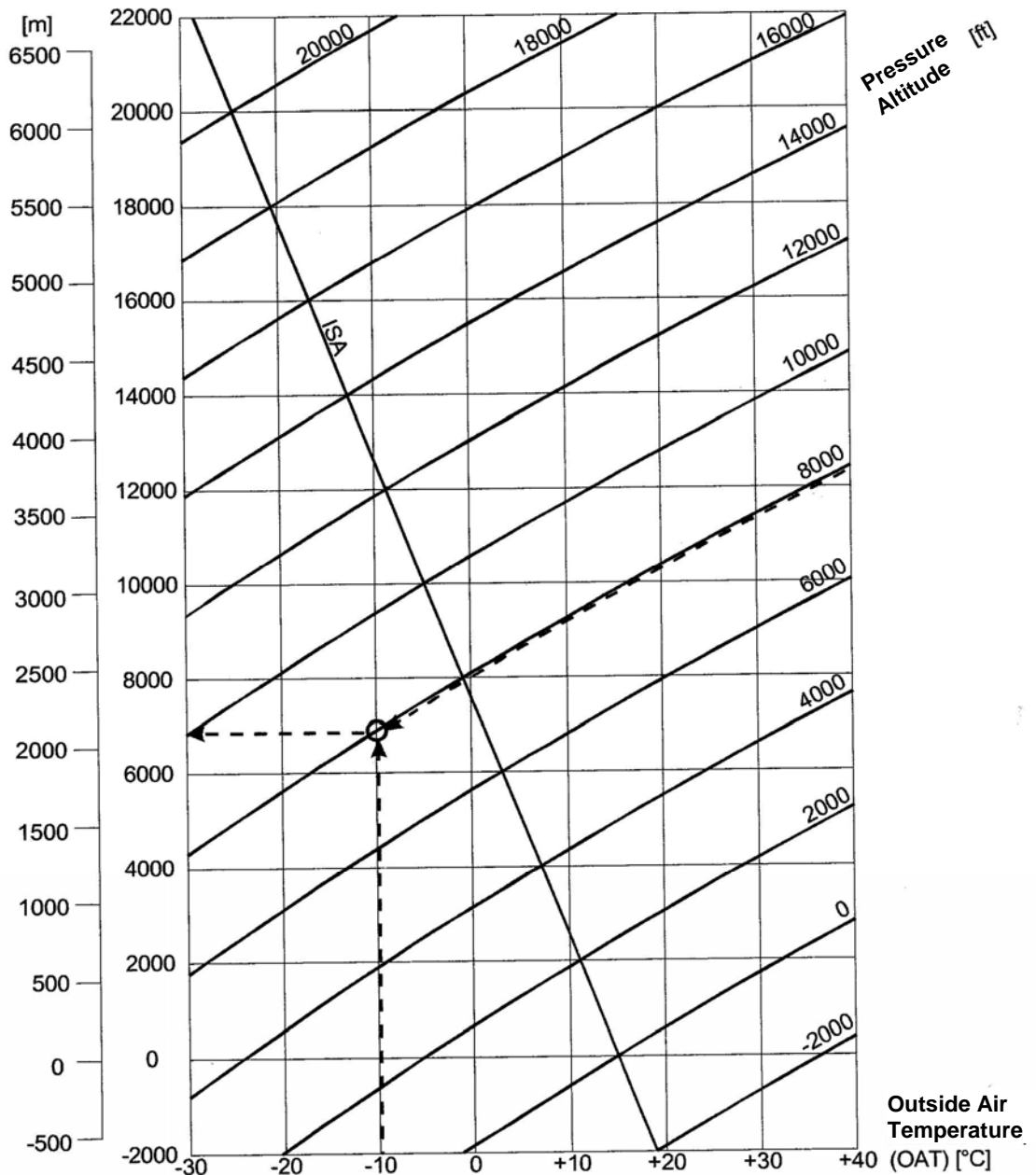



Aircraft Operating Instructions (AOI)

Type: *CT*

Series: *CTLS LSA*

Page: 5-3

An example is given in this diagram. Outside air temperature is -10°C (14°F .) and the altimeter shows a (pressure) altitude of 8000ft.

Warning: pressure altitude can be obtained with the reference pressure of the altimeter set to standard atmosphere = 1013.25 hPa (=29.92 in Hg) only.

The corresponding density altitude is 6800 ft or 2100 m. Performance values are thus equivalent to those given in the next chapter for 2100 m. If the pressure altitude of 2400 m (8000 ft) were used, the performance figures would be wrong. This difference can be very significant, particularly in the summer months when the density altitude is much higher than the pressure altitude due to the higher temperatures.

5.3. Significance of the wind component

Wind directly affects the flight path and thus aircraft performance. Two diagrams are presented below which show the significance of the wind component.

5.3.1. Wind influence on take-off roll and landing

To determine whether the aircraft can take-off safely, it is necessary to determine the prevailing crosswind component. On the one hand, this determines the appropriate take-off procedure while, on the other hand, it ensures that the demonstrated permissible crosswind component for take-off and landing is not exceeded. The following diagram is used to determine the crosswind component.

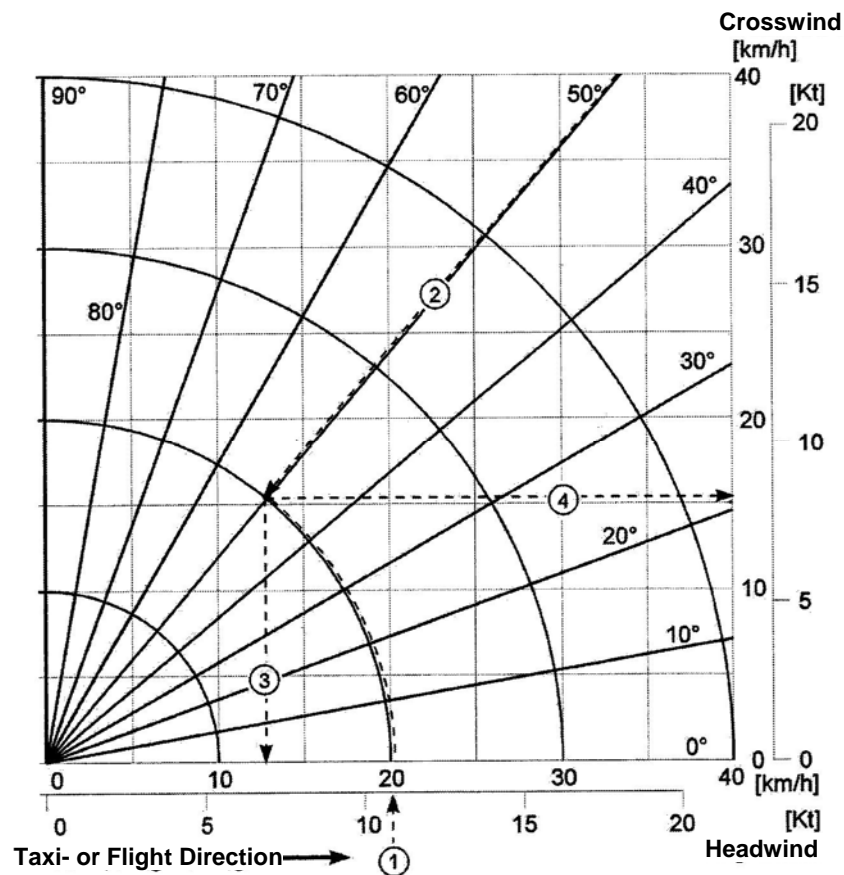

An example is shown in the diagram. Take-off direction is 120°. The wind direction is 070°, wind speed 11 kts. The wind angle is thus $120^\circ - 70^\circ = 50^\circ$. Wind speed is plotted along the circle segment (1) to the point where it intersects the wind angle (2). The corresponding value on the x-axis (3) results in a head wind component of 7.1 kts, the value on the y-axis (4) in a crosswind component of 8.4 kts.

Values for landing are determined in a similar manner.

5.3.2. Wind influence on cruise

Wind also has a noticeable influence on the forward progress of the aircraft over ground in cruise. The relevant components can be easily calculated from the graph.

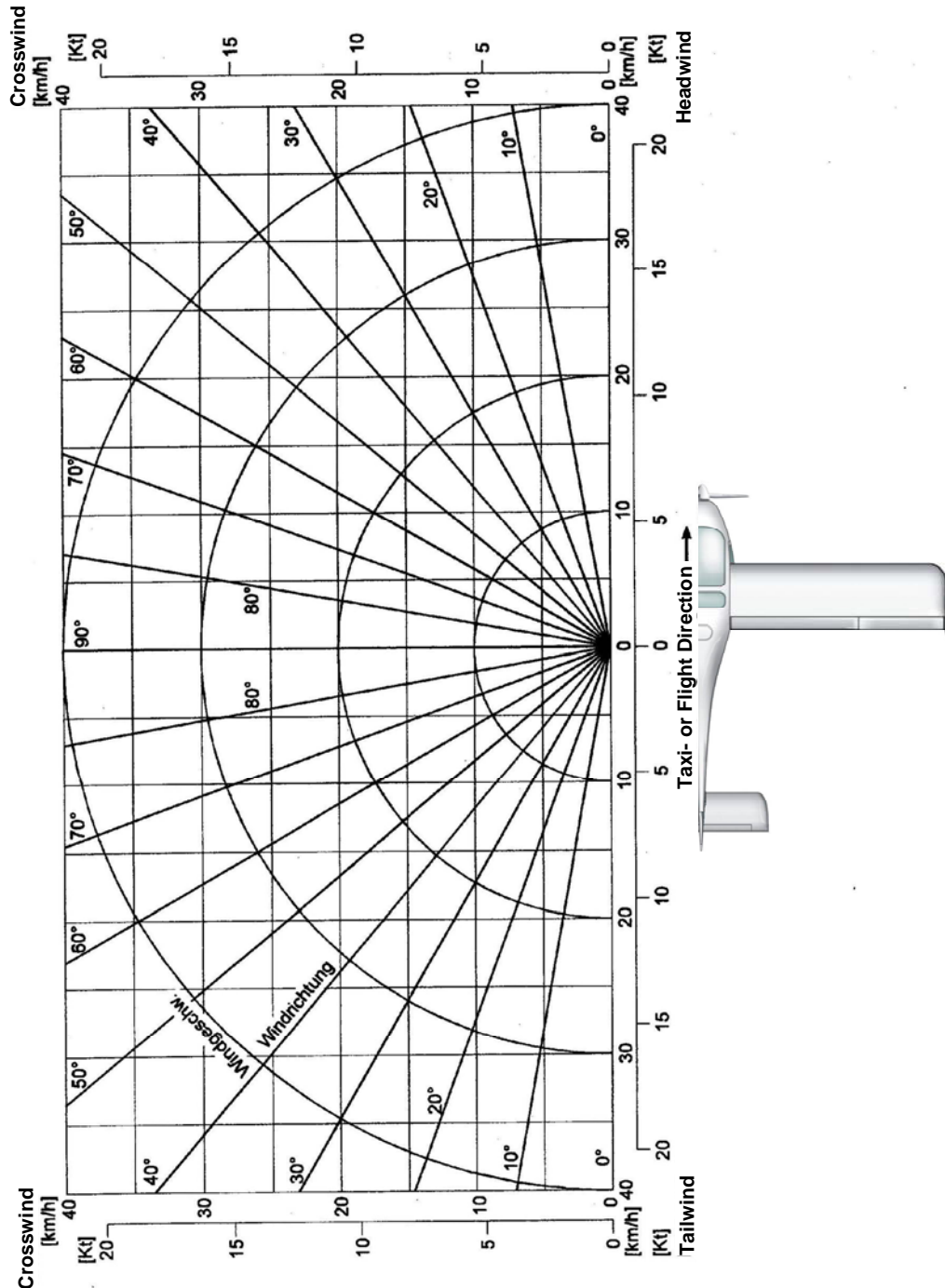

Calculation procedures are analogous to those used to determine take-off procedures, the only difference being the possible inclusion of a tailwind component.

5.4. Engine performance subject to altitude

Engine performance decreases with increasing (density) altitude. The following data may be used to determine available engine performance.

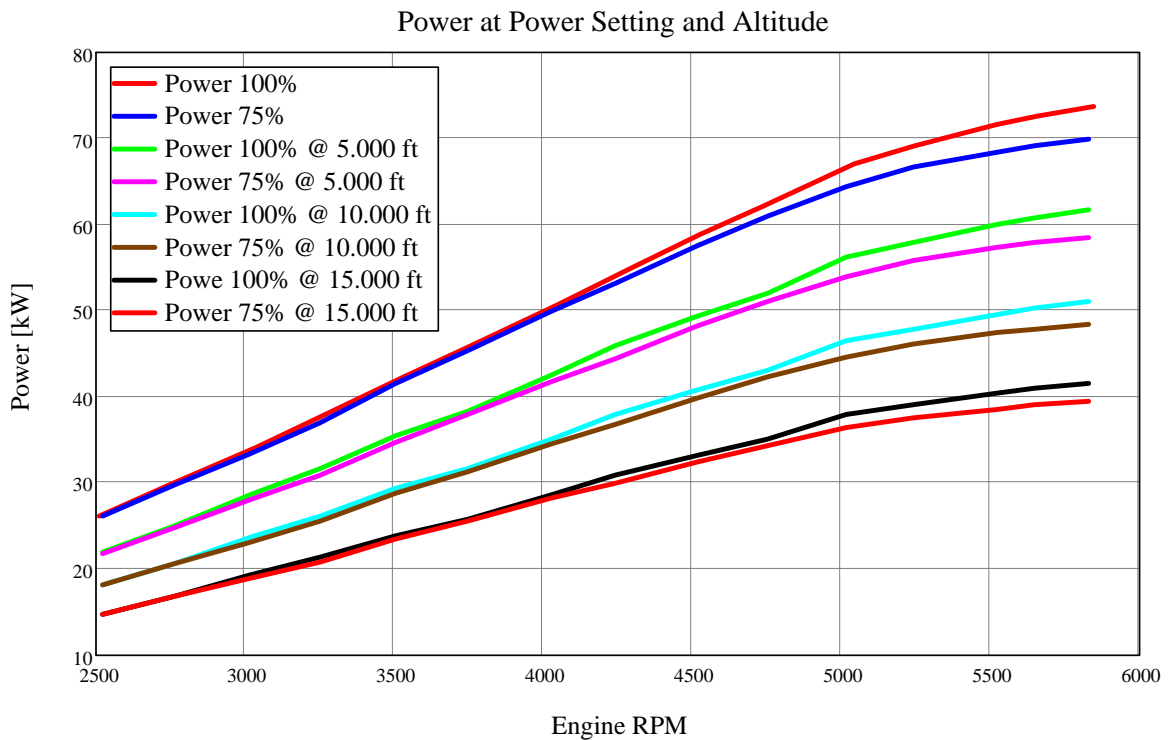
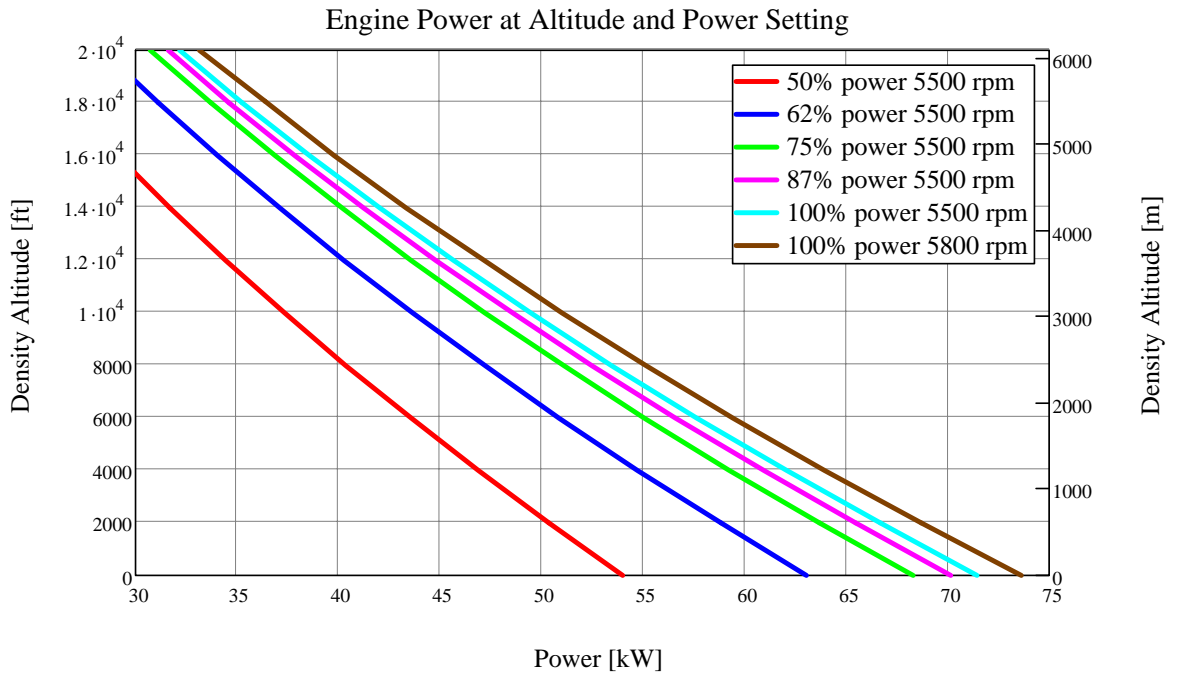

	Aircraft Operating Instructions (AOI)	
	Type: <i>CT</i>	Series: <i>CTLS LSA</i> Page: 5-7

5.5. Calculating the take-off distance

Takeoff distances in the following charts have been analyzed for varying conditions and takeoff weights using FAA approved analysis methods.

Warning: Important for the usage of these charts is again the correct density altitude. Field elevation is not sufficient, as this does neither consider local day air pressure nor local temperature. Both have noticeable effect to the takeoff performance.

Warning: Don't forget that these are handbook methods which, in practice, are heavily dependent upon many factors and in particular from the way the take-off is actually performed. The values are based on an aircraft in good conditions piloted by an experienced pilot. Always add a reserve to the data which takes into consideration the local conditions and your level of piloting experience.

5.5.1. Take-off distance charts

The take-off roll distance defines the distance between the begin of the take-off roll and the point where the aircraft leaves the ground. This distance is given for short mown grass on a hard and dry level soil, without wind influence. Distances for concrete are comparable with the CTLS.

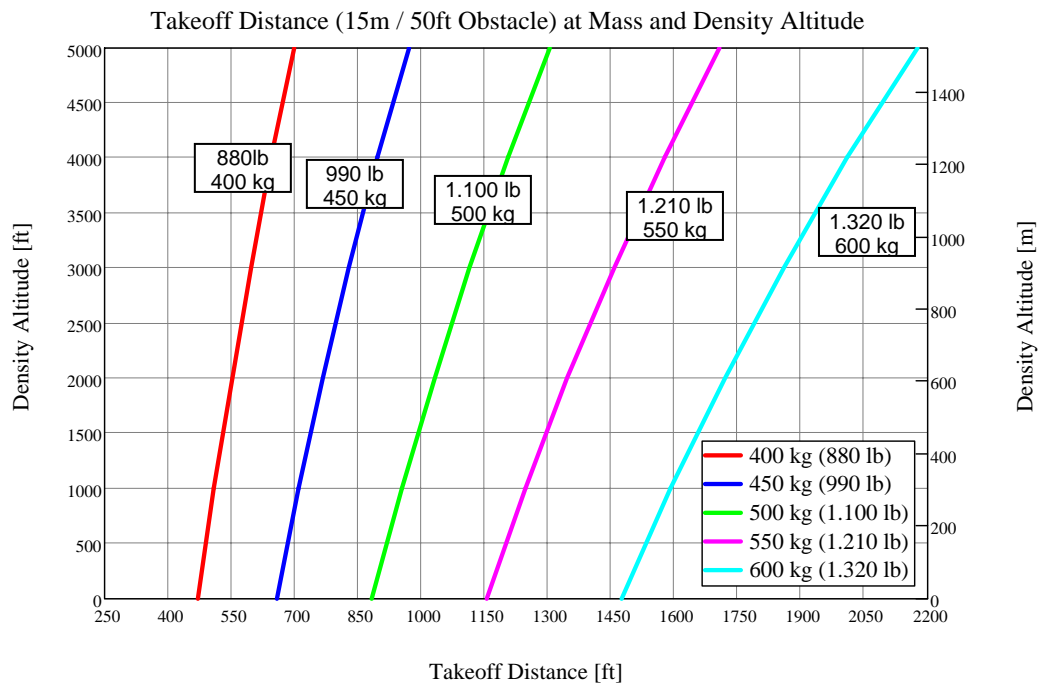
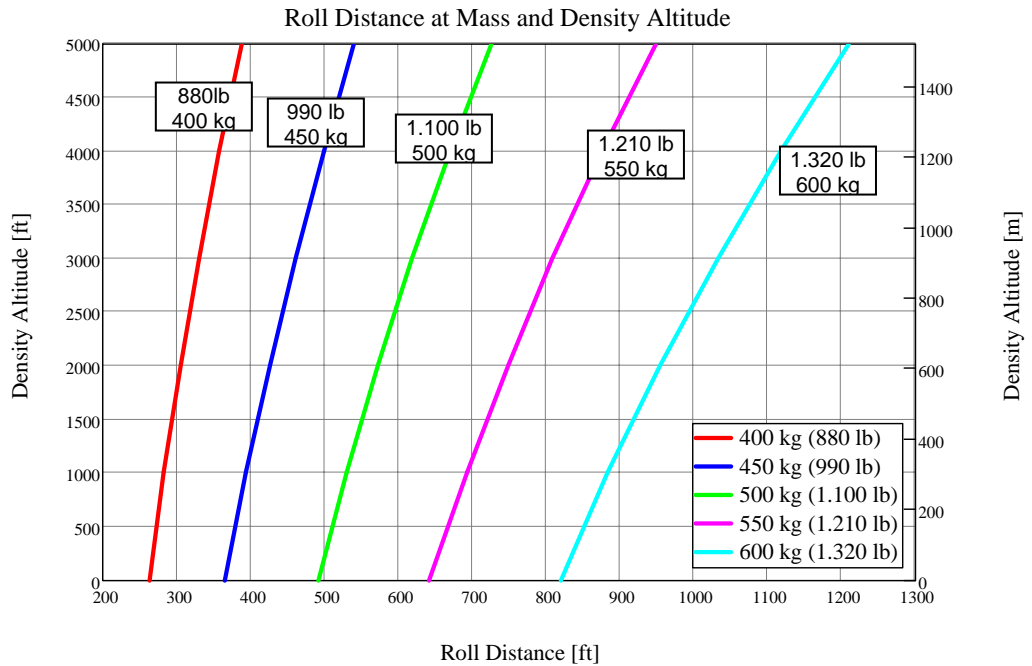

5.5.2. Influences to take-off distance

Take-off performance for conditions different to the ones named before can be estimated by using the following rules of thumb. Again the basis is an aircraft in good condition and a well trained pilot.

Influence	Increase of take-off roll distance	Increase of take-off distance
high grass 8 in (20cm)	app. 20% (= x 1.2)	app. 17% (= x 1.17)
Flaps 0° instead of 15°	app. 10% (= x 1.1)	app. 20% (= x 1.2)
2% inclination of runway	app. 10% (= x 1.1)	app. 10% (= x 1.1)
4% inclination of runway	app. 14% (= x 1.14)	app. 12% (= x 1.12)
tail wind 5 kt	app. 20% (= x 1.2)	app. 25% (= x 1.25)
wet snow	app. 30% (= x 1.3)	n/a
soaked soil (1.2 in (3cm) deep)	app. 16 % (= x 1.16)	n/a

Each factor occurring at a time has to be considered individually.

Example: Takeoff at 1.100 lb (500 kg) at 68 F (20°C) at 2000 ft (600 m) pressure altitude in high grass with a runway 2% inclination. As by chapter 5.2 density altitude for this case is 3000 ft (900m). Takeoff charts show a take-off roll distance of 620 ft (190 m) and a take-off distance of 1.120 ft (340 m). Consideration of the deviating factors delivers: Take-off roll = 620 ft x 1.2 x 1.1 = 820 ft (250 m) and Take-off distance = 1.120 ft x 1.17 x 1.1 = 1.440 ft (440 m). Easy to see that just using the field elevation (200 ft) would have delivered values by 40% too low.

5.6. Calculating climb performance

The aircraft is nearly always operated under different conditions than ISA standard atmosphere. Aircraft climb performance under different conditions can be estimated according to the following tables. The basis for these values is an aircraft in good conditions. Best climb is achieved with 0° flaps. Data are provided for 0° and 15° flaps (climb and take-off condition).

Warning: Knowledge of the correct density altitude is mandatory to obtain reliable values for the aircraft performance.

Climb performance at flaps 0°

density alt [ft]	Aircraft weight 472.5 kg (1042 lbs)			Aircraft weight 600 kg (1320 lbs)		
	rate of climb [ft/min]	rate of climb [m/s]	at CAS [kts / km/h]	rate of climb [ft/min]	rate of climb [m/s]	at CAS [kts / km/h]
0	1000	5,0	72 / 130	800	4,0	73 / 132
5.000	720	3,6	71 / 128	520	2,6	72 / 130
10.000	500	2,5	69 / 125	260	1,3	71 / 128
12.000	400	2,0	68 / 122	120	0,6	69 / 126
15.000	300	1,5	67 / 120	-	-	-

Climb performance at flaps 15°

density alt [ft]	Aircraft weight 472.5 kg (1042 lbs)			Aircraft weight 600 kg (1320 lbs)		
	rate of climb [ft/min]	rate of climb [m/s]	at CAS [kts / km/h]	rate of climb [ft/min]	rate of climb [m/s]	at CAS [kts / km/h]
0	900	4,5	64 / 115	740	3,7	67 / 120
5.000	680	3,4	64 / 115	460	2,3	66 / 118
10.000	440	2,2	62 / 112	280	1,4	64 / 115
12.000	380	1,9	62 / 111	100	0,5	62 / 113
15.000	260	1,3	61 / 110	-	-	-

5.7. Gliding characteristics

The following chart shows the distances the aircraft can glide, dependent upon altitude, assuming smooth air, no wind and no vertical air currents.

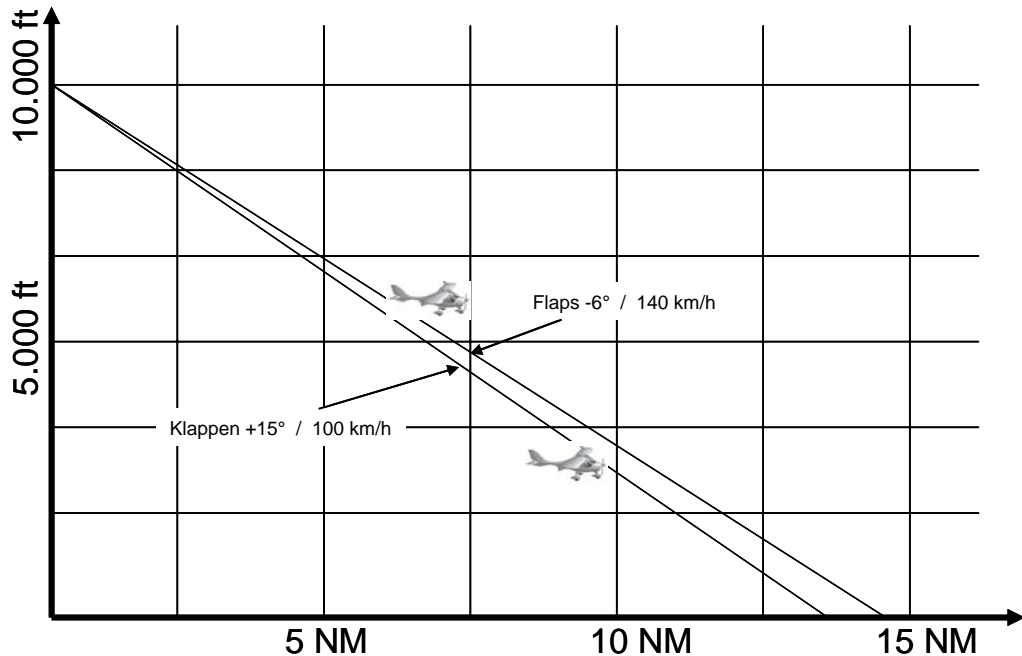

Warning: Intensive thermal activity can prolong these distances. Turbulence, however, usually leads to a reduction in gliding distance. One should never expect favorable conditions when estimating a possible gliding distance!

Glide angle of the CTLS can be assumed in practice to be 8.5 to 1. With flaps extended this ratio gets worse. One effect of moderately set flaps is to reduce the minimum sink, but the speed at which the minimum sink is observed reduces faster. This results in a reduced possible gliding distance. Speeds for best glide at flight mass and negative flaps can be assumed as follows:

600 kg (1320 lbs)	140 km/h (78 kts)
500 kg (1100 lbs)	124 km/h (69 kts)
400 kg (880 lbs)	115 km/h (64 kts)

5.8. Calculating the landing distance

Landing distances in the following charts have been analyzed for varying conditions and takeoff weights using FAA approved analysis methods.

Warning: Important for the usage of these charts is again the correct density altitude. Field elevation is not sufficient, as this does neither consider local day air pressure nor local temperature. Both have noticeable effect to the takeoff performance.

Warning: Don't forget that these are handbook methods which, in practice, are heavily dependent upon many factors and in particular from the way the landing is actually performed. The values are based on an aircraft in good conditions piloted by an experienced pilot. Always add a reserve to the data which takes into consideration the local conditions and your level of piloting experience.

5.8.1. Landing Distance Charts

The landing distance is determined for a landing over an obstacle of 50 ft (15 m) height up to a full stop of the aircraft. The landing roll distance defines the distance between touch down and the point where the aircraft comes to full stop. This distance is given for short mown grass on a hard and dry level soil, without wind influence. Distances for concrete are comparable with the CTLS.

Warning: Be aware that obtaining these minimum landing distances requires perfect following of the landing procedures and good training on the actual aircraft.

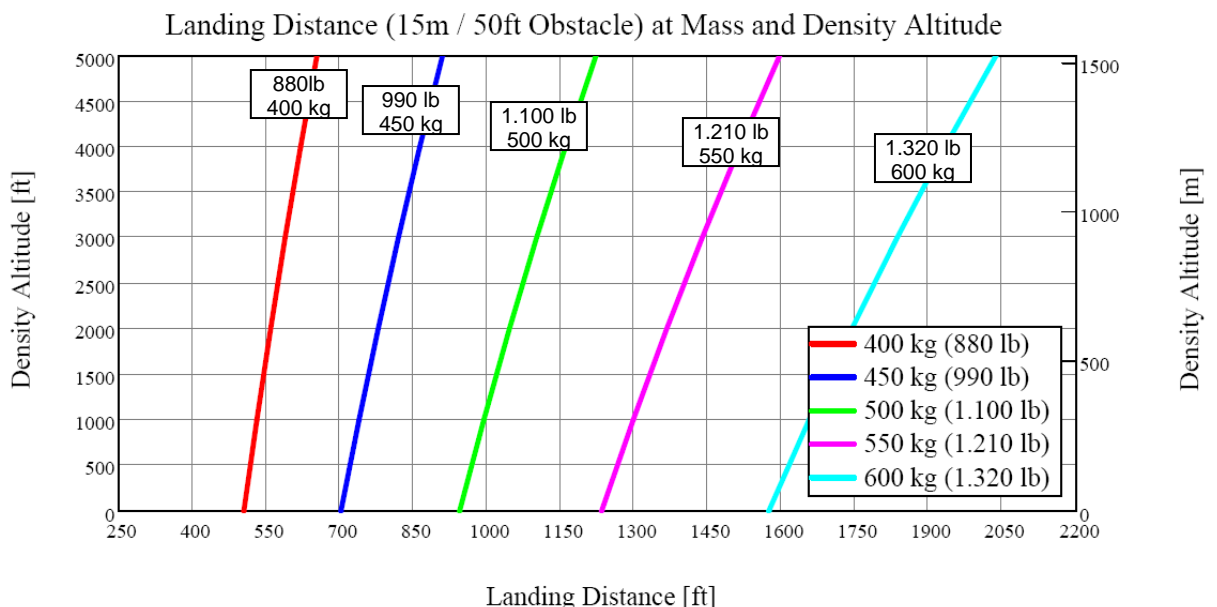

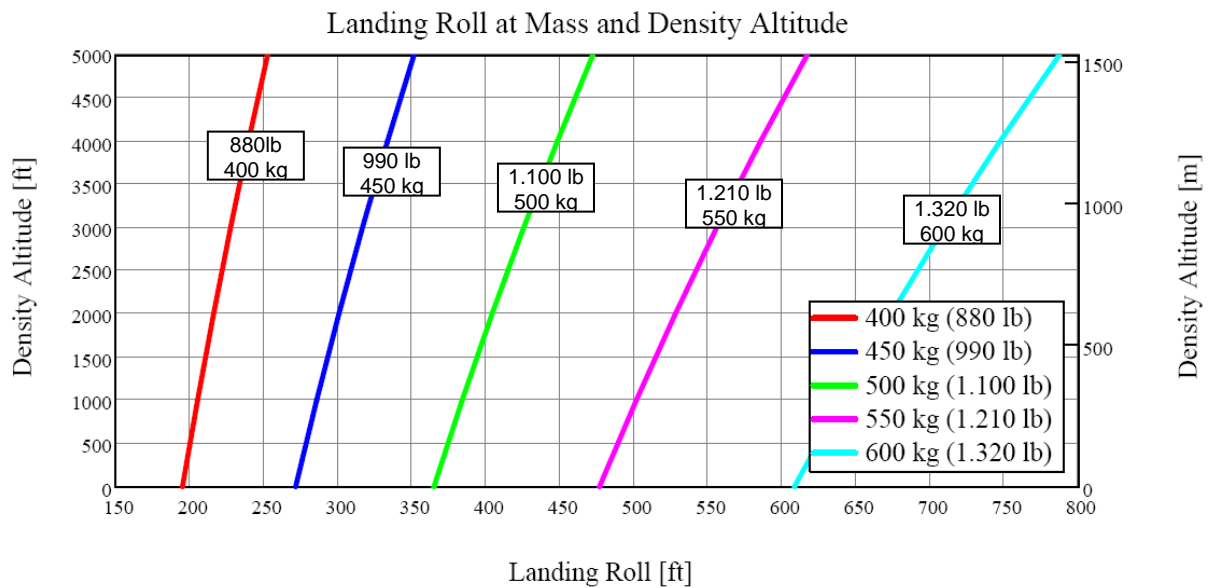

5.8.2. Influences to landing distance

Landing performance for conditions different to the ones named before can be estimated by using the following rules of thumb. Again the basis is an aircraft in good condition and a well trained pilot.

Influence	Increase of take-off roll distance	Increase of take-off distance
2% inclination of runway	app. +/-10% (= x 1.1)	app. +/-10% (= x 1.1)
4% inclination of runway	app. +/-14% (= x 1.14)	app. +/-12% (= x 1.12)
tail wind 5 kt	app. 20% (= x 1.2)	app. 25% (= x 1.25)

Each factor occurring at a time has to be considered individually.

Example: Landing at 1.100 lb (500 kg) at 68 F (20°C) at 2000 ft (600 m) pressure altitude on a runway 2% inclination downwards. As by chapter 5.2 density altitude for this case is 3000 ft (900m). Landing charts show a landing distance of 1100 ft (335 m) and a landing roll distance of 450 ft (140 m). Consideration of the deviating factor delivers: Landing roll = 450 ft x 1.1 = 495 ft (150 m) and landing distance = 1.100 ft x 1.1 = 1.210 ft (370 m).

6. WEIGHT AND BALANCE, EQUIPMENT

6.1. Weight Limits

The following limits ensure the safe operation of the aircraft:

Maximum take-off weight (MTOM)	450 kg ... 600 kg (992 lbs -1320 lbs) according to national laws and certification requirements
Minimum crew weight	60 kg (120 Lbs)
Maximum load per seat	120 kg (260 lbs)
Maximum baggage load, total	50 kg (110 lbs)
... in each compartment / side, max.	25 kg (55 lbs)
Center of gravity range:	0,282 – 0,478 m (11.1in – 18.8 in) Datum is the wing leading edge

6.2. Weighing

To weigh the aircraft, three scales must be set on a level floor. The aircraft is leveled by shimming either the nose wheel or both of the main wheels. It is in the correct position for weighing when the tunnel (where the throttle quadrant is located) in the cockpit is in the horizontal. The aircraft must also be level span-wise. This can be determined by placing a level on the cabin roof in the vicinity of the skylight.

Using a plumb bob, the middle of the wheel axles is projected on to the floor and marked. The same procedure is used to mark the reference datum. A plumb bob is dropped from the wing leading edge on the outer side of the root rib. The transition to the fuselage is faired in the root rib area which can lead to an incorrect measurement. The distance between the wheels must be measured during each weighing. These values must be then be used in the tabulation. If the original Flight Design weighing form is used as a spread sheet, the distances must be recorded with a positive algebraic sign. If the calculations are done manually, one must be careful to use the proper algebraic signs.

It is easy to make mistakes when weighing, particularly if the scales are interfered with by a side-load (e.g. due to landing gear strut compression). It is therefore very important that the weighing process remains free from distortion. Distortion can be avoided if at least one of the main wheels (better both) is placed on a pair of metal plates with grease in between. The two plates slide easily on each other which reduces the tension due to side-loads virtually to zero.

An example of a weighing record is given below. The weighing data for the aircraft as delivered from the factory is to be found in this Pilot's Operating Handbook and Maintenance Manual. It is the responsibility of the owner of the aircraft to ensure that the aircraft is weighed after any relevant changes (change in equipment; repair work). Furthermore it is mandatory that the main mass data be recorded on the relevant page of the aircraft logbook.



Weight and Balance of LSA Aircraft XXXX

Type:	CT
Model:	CTLS
Production Number:	xx-xx-xx
Engine Number:	yyyyyy
Equipment list with date:	dd-mm-yyyy
Grey fields require inputs	

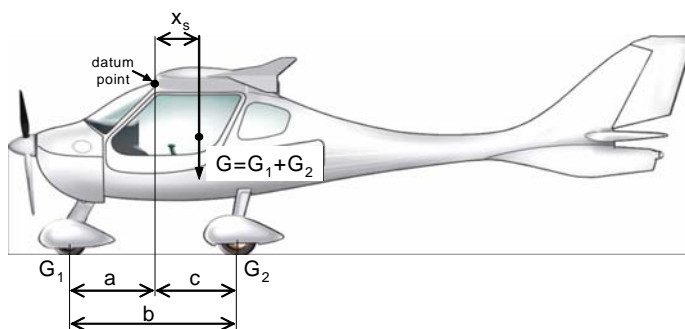

Datum Point:	Wing leading edge	Datum Plane:	Tunnel roof in cabin horizontal
--------------	-------------------	--------------	---------------------------------

Scaling and Empty Aircraft cg

Support point	Gross weight	Tara	Net weight	Distance to ref	Moment
Nose wheel	169,75 lb	0,00 lb	169,75 lb	33,9 in	-5748 lb*in
Main wheel left	266,75 lb	0,00 lb	266,75 lb	28,3 in	7562 lb*in
Main wheel right	264,11 lb	0,00 lb	264,11 lb	28,3 in	7487 lb*in

Deductions					
Fuel		0 gal	0,00 lb	8,3 in	0 lb*in

Empty Weight and cg	700,62 lb	13,3 in	9301 lb*in
----------------------------	------------------	----------------	-------------------

Component weight	
Wing left	78,92 lb
Wing right	77,60 lb
Stabilizer	12,35 lb
Rudder	4,63 lb
Fuselage	527,12 lb
Control sum	700,62 lb
Weight of non-lifting parts	700,62 lb

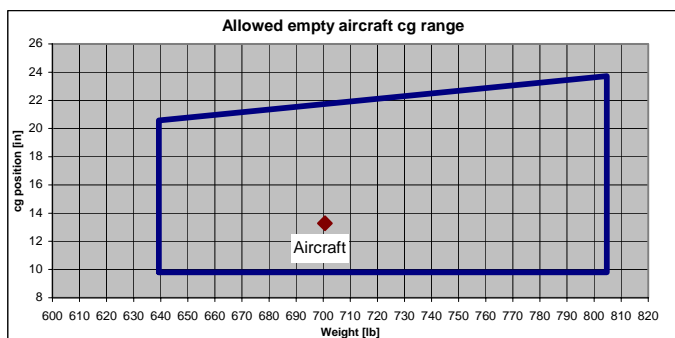

Summary:

Certification Basis	
MTOW	1322,75 lb
Max weight of non-lifting parts	1144,18 lb

Data of Aircraft	
Empty weight	700,62 lb
Max payload	622,13 lb
Max pl. fuselage	600,09 lb

Fedchun
Signature

Kherson, Ukraine
City

17.Oct.2007
Date

Warning: The empty weight data in this example does not correspond to an actual aircrafts. Use only the empty weight and center of gravity data from the most current weight record!

The weighing record provides an insight into the state of the aircraft at the time of weighing. In addition to the empty weight with the currently installed equipment and the relevant center of gravity, the weighing record also states the empty weight with

	Aircraft Operating Instructions (AOI)		
	Type: <i>CT</i>	Series: <i>CTLS LSA</i>	Page: 6-3

standard equipment installation. The MTOW as defined by the certification regulations and the maximum weight of the aircraft as defined for structural proofs are used to calculate the maximum permissible payload and the maximum payload in the fuselage. A diagram in the weighing form gives information about the position of the empty weight center of gravity. The aircraft is designed to make it impossible for the permissible center of gravity to be exceeded when the aircraft has been loaded within the limits set down in this handbook and the empty weight is within the specified range. If necessary, trim ballast weight should be installed.

The weighing record is only valid in connection with the current equipment list. Any changes to the aircraft must be appropriately registered. It is also possible that national regulations require weighing to be carried out at specified intervals or after specified work on the aircraft. It is the responsibility of the owner to conform to such national requirements.

The aircraft is operated in different countries under different certification regulations. There is also a wide variety of options available for the aircraft, some of which may not be installed in some countries. A variety of these options can also lead to an increase in aircraft empty weight which exceeds that set down in the certification regulations of some countries. It is the responsibility of the owner to ensure that national regulations concerning aircraft specification and operation are followed.

AF 043 00005	Revision No. 4	Date: 29 Apr 2008
--------------	----------------	-------------------

6.3. Flight Mass and Center of Gravity

The flight mass and the connected center of gravity in flight must be determined prior to each flight. The following table and charts provide you with all necessary information to perform this part of your flight preparation.

Warning: You always have to expect that you burn all your fuel during one flight. Therefore, in all cases both conditions have to be verified to be within allowed limits: With tanks filled as on takeoff, and with tanks completely empty. In no case you may neither get out of the allowed cg range nor exceed MTOM as certified in your relevant country.

Warning: Explicit data used as example in the following charts have nothing to do with your real aircraft. The only purpose of these data is to illustrate the process of determining the required values for the flight planning. In any case you must make sure that you take the correct data as valid for your individual aircraft.

		<i>CTLS example</i>		<i>Your CTLS</i>	
		Mass [kg] [lb]	Mass Moment [kg*m] [in*lb]	Mass [kg] [lb]	Mass Moment [kg*m] [in*lb]
1.	Empty mass & mass moment (from most recent, valid Weight and Balance Report)	318 701	107,1 9.318		
2.	Combined pilot and passenger mass on front seats Lever arm: 0,52 m (20,5 in)	85 190	44,2 3.895		
3.	Mass loaded to luggage compartment behind the cabin Lever arm: 1,140 m (45 in)	12 25	13,7 1.125		
4.	Mass loaded to luggage compartments in foot area in front of the seats Lever arm: -0,335 m (-13,2 in)	0 0	0 0		
5.	Total mass & total mass moment with empty fuel tanks (total of 1. – 4.)	415 916	165 14.338		
6.	Center of gravity with empty fuel tanks (Mass Moment of 7. divided by Mass of 7.)	0,398 m 15,6 in		m in	
7.	Usable fuel as verified to be filled on the aircraft * Lever arm: 0,21 m (8,3 in)	43 95	9,0 789		
8.	Total mass & total mass moment including fuel (5. plus 7.)	458 1.011	174 15.127		
9.	Center of gravity including fuel (Mass Moment of 8. divided by Mass of 8.)	0,380 m 15,0 in		m in	
10.	The results in lines 5. and 8. must be all within the certified limits as defined for this aircraft in Chapter 6.1. Mass moments can be checked in the mass moment chart below. The results in lines 6. and 9. must be both within the limits as defined for this aircraft in Chapter 6.1				

* One Liter of fuel weighs 0.725 kg – one US gal of fuel weighs 6.05 lb.



Aircraft Operating Instructions (AOI)

Type: *CT*

Series: *CTLS LSA*

Page: 6-5

The table above provides you with the calculation scheme for the aircraft center of gravity for your flight. You have the possibility to calculate the moments analytically, or to read them from the following diagrams. Both methods will lead to the same result. Always make sure that you calculate the results for your takeoff configuration, and for the configuration with empty fuel tanks. In both cases the center of gravity must be within the defined limits.

The following chart "Loading Diagram" provides you with a graphical method to determine the mass moments of the individual positions. To obtain the value, select the correct weight (or volume) on the vertical axis. Go horizontally to the intersection with the correct loading graph. Go vertically down to the horizontal axis to obtain the mass moment value. Enter this mass moment value to the correct line in the analysis table above.

The next chart "Permissible Moment Range" allows you to verify if your aircraft is within the allowable moment range. The allowable range is shaded in this chart. Six center of gravity positions are marked as lines.

The third chart "Permissible CG Range" allows you to verify if your aircraft is within the allowable cg range. The allowable range is shaded in this chart. Forward and aft cg limit, as well as maximum permissible flight mass are marked as lines. This allows you to determine the actual center of gravity position you have achieved.

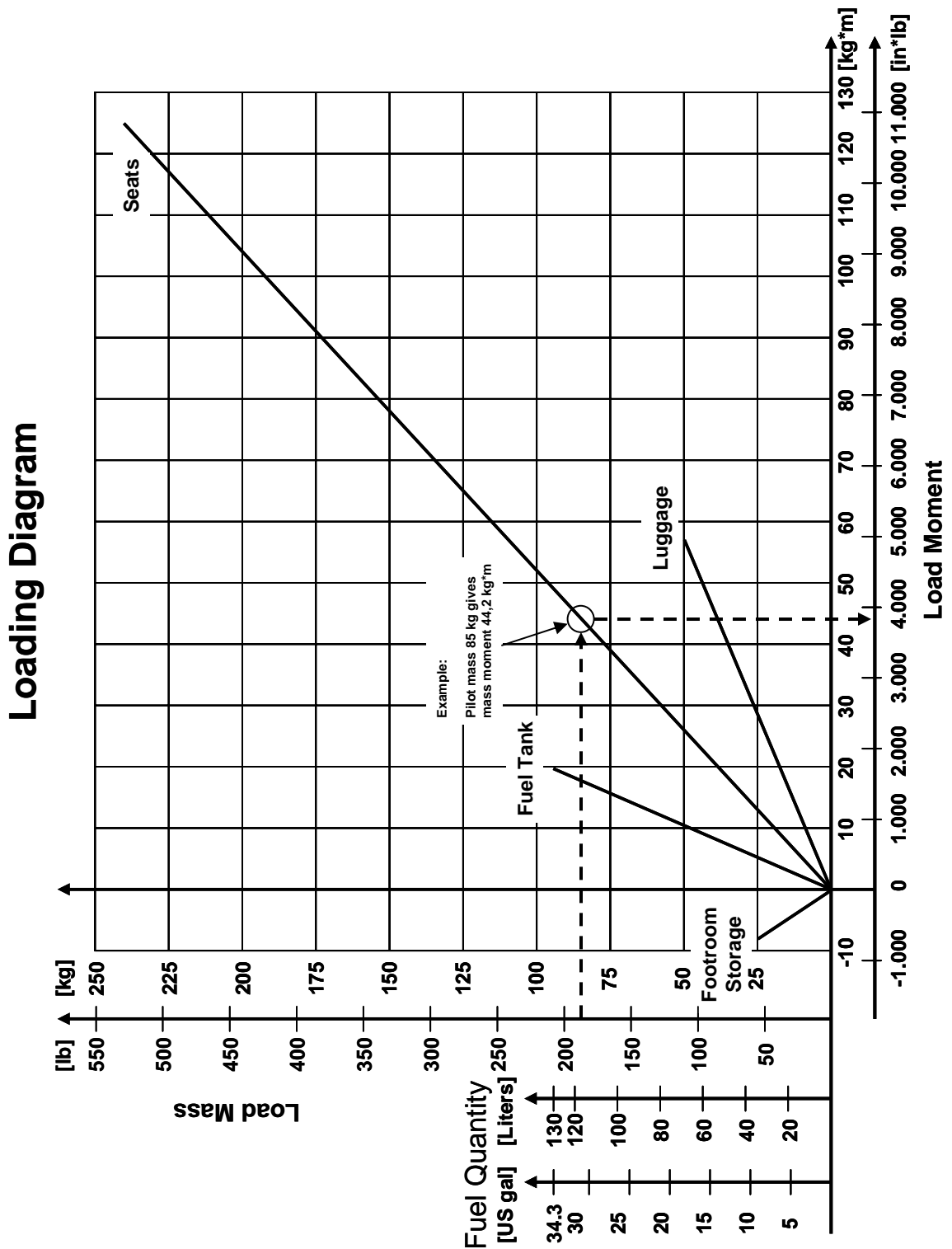

The example shown in this diagram represents the determination of the mass moment value as by the example shown in the analysis table. The pilot mass of 85 kg (190 lb) is selected at the vertical axis. Intersection with the line „Seats“ leads to a mass moment of 44,2 kg*m (3895 in*lb).

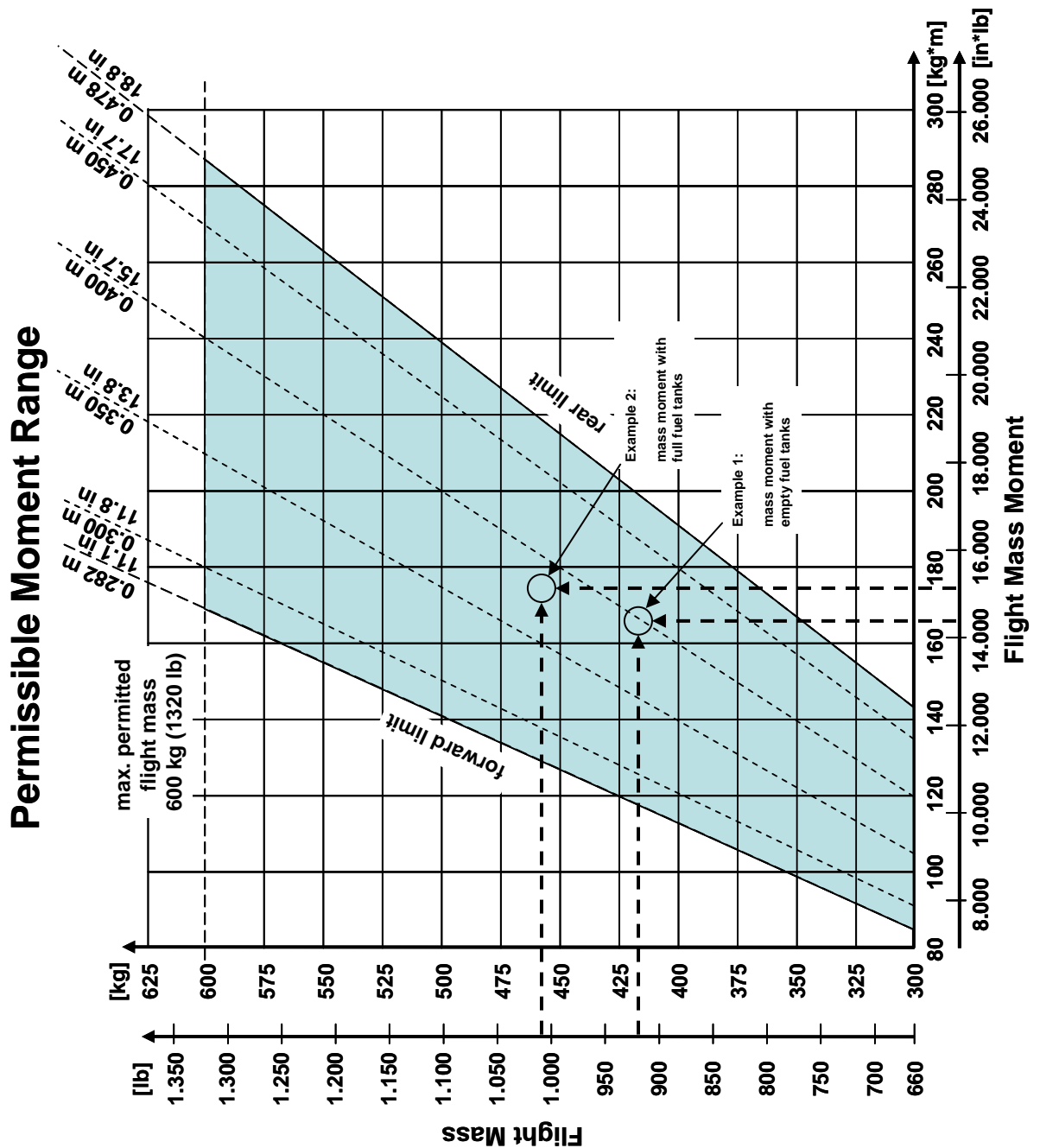

The example shown in this diagram represents the verification of the mass and mass moment values achieved as by the example shown in the analysis table. The aircraft with no fuel is represented by the values 415 kg (916 lb) and 165 kg*m (14.338 in*lb). The aircraft takeoff fuel is represented by the values 458 kg (1.011 lb) and 174 kg*m (15.127 in*lb). Both values are within the allowed range. The two center of gravity positions can be determined as 0,380 m (15,0 in) and 0,400 m (15,7 in)

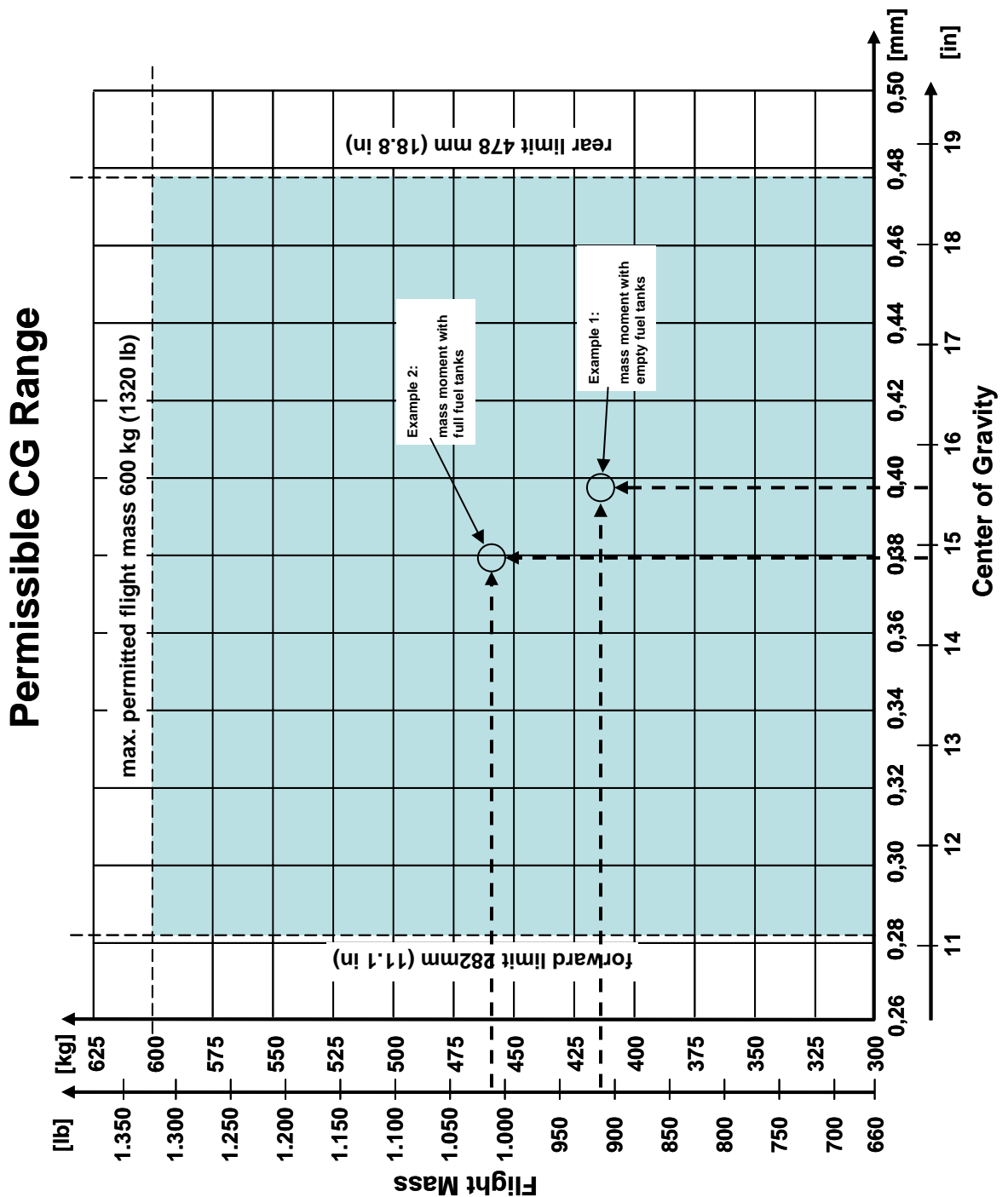

The example shown in this diagram represents the verification of the mass and cg position values achieved as by the example shown in the analysis table. The aircraft with no fuel is represented by the values 415 kg (916 lb) and 380 mm (15,0 in). The aircraft takeoff fuel is represented by the values 458 kg (1.011 lb) and 0,398 m (15.6 in). Both values are within the allowed range.

	Aircraft Operating Instructions (AOI)	
	Type: <i>CT</i>	Series: <i>CTLS LSA</i> Page: 6-9

6.4. Equipment

An example of an equipment list is given below. Each aircraft is delivered with an initial equipment list as part of this handbook. A new equipment list must be compiled and added to aircraft logbook and to this manual when there is any change to the equipment. The owner of the aircraft is responsible for ensuring that the equipment list is current.

The equipment list includes options which are not certified in all the countries in which the CTLS may be operated. It is the responsibility of the owner to ensure that national regulations are followed, for example with respect to the ballistic recovery system and the autopilot.

The equipment list is a summary of the aircraft at the time of an annual inspection or weighing. It is mandatory to record the installation and/or removal of instruments in the aircraft logbook.



7. AIRPLANE AND SYSTEMS DESCRIPTION

7.1. Airframe

The CTLS is a conventional high-wing aircraft. The wings can be easily removed but should only be removed after appropriate instruction as important control elements and the fuel system must be properly attached on remounting.

The horizontal tail of the CTLS is a stabilator (all-moving horizontal tail). To improve control feel, an anti-servo tab has been attached which moves in the opposite direction as the stabilizer when deflected. This anti-servo tab can be adjusted via the standard stabilator trim and is attached to the horizontal tail by means of a composite membrane which provides an aerodynamically clean attachment to the anti-servo tab.

The spacious cockpit is comfortably accessible to the pilot and passenger via two large doors held open by gas struts. The extensive acrylic windshield offers, for a high-wing aircraft, outstanding visibility. The rear side windows which have been added to the CTLS allow rearward vision and give the cabin a more open feeling.

Behind the cockpit there are baggage compartments on the right and left side with standard tie-downs for simple baggage. The baggage compartments are accessed via lockable hatches on the side of the aircraft to facilitate loading and unloading.

7.1.1. Assembly instructions

Assembly and disassembly of an LSA aircraft is only allowed to licenced mechanics. Instructions for assembly and disassembly are given in the separate CTLS LSA maintenance manual.

7.1.2. Materials used for the airframe

The airframe is made of high-quality composite materials which permit excellent aerodynamic characteristics to be achieved at an efficient structural weight.

Due to the strict weight regulations for light sport aircraft, reinforced carbon and aramide fiber materials are used in the more advanced designs.

Due to the complex nature of composite materials and the necessary knowledge in the lay-up of a specific structure, repair work on the composite airframe may only be undertaken by a qualified facility. For this reason, only general information about the materials used is given in this handbook. Should the aircraft structure be damaged, detailed information must be requested from the manufacturer.

Carbon, aramide, glass fiber:	various qualities Lange & Ritter, Gerlingen
Resin and hardener:	Larit L 285 Lange & Ritter, Gerlingen
Core material:	Rohacell, Airex various qualities Lange & Ritter, Gerlingen
Screws and bolts:	unless otherwise stated, class 8.8 zinc-plated or stainless steel, according to DIN standard

7.1.3. Baggage compartments

The aircraft has three different baggage compartments:

- 1) a baggage compartment behind the pilots' seats
- 2) a hat or jacket rack at the main frame, behind the seats
- 3) storage locker in the floor in front of the seats

Warning: Baggage must be carefully stored in all of the compartments. Even in apparently calm weather, turbulence can occur at any time. Baggage poses a great danger as it can slip in such a way as to adversely affect or even block the controls. Loose objects flying around in the cockpit can injure the pilot and/or passengers. Displaced baggage can also adversely affect the center of gravity of the aircraft, making it no longer controllable.

The baggage compartment in the fuselage barrel behind the pilots' seats has a maximum payload of 25 kg (55 lbs) on each side. Inside each of the compartments, hooks are attached to the fuselage walls with the help of which baggage can be secured.

The hat rack offers storage space for small and flat objects only. The size of the object may not exceed 25 cm x 25 cm x 8.5 cm (10 in x 10 in x 4 in) nor weigh more than 2.5 kg (5 lbs). This storage space may only be used if the baggage net is in place. The net can be removed to facilitate loading. It must be hung back on all three hooks when loading has been completed.

The storage compartment in the floor in front of the seats is for small, light objects only. For example, snacks, water bottle, light tools or the fuel dipstick, etc. can be stored here. The cover must be closed during flight.

Warning: The pilot is responsible for ensuring that any baggage has been properly stored before take-off.

7.2. Systems

7.2.1. Engine

The engine of the CTLS is a standard Rotax 912 ULS engine. It is a horizontally opposed, four cylinder, four stroke engine with central camshaft-push rod-OHV, liquid-cooled cylinder heads and a dry sump, pump-fed lubrication system. The propeller is attached to the engine by an integrated gearbox (2.43:1 reduction) with a mechanical vibration damper. It is also equipped with a Bing constant pressure carburetor. The engine has an electric starter and a capacitive discharge (CDI)-dual ignition.

As an option the engine can be equipped with a friction clutch and thermostats for the oil and water-cooling systems.

Air is fed into the engine via an aluminum air box which fills both carburetors with equal volumes. Fresh air is fed into the system via a cylinder air filter attached to the fire wall in an expanding chamber. The expanding chamber is supplied by a NACA air inlet located on the right side of the lower cowling. When the carburetor heat is on, air flow into the aluminum air box changes from fresh air to heated air. The heated air comes from the same exhaust shroud as supplies the cabin heating system. Air for this shroud is supplied from an inlet in the front underside of the lower cowling.

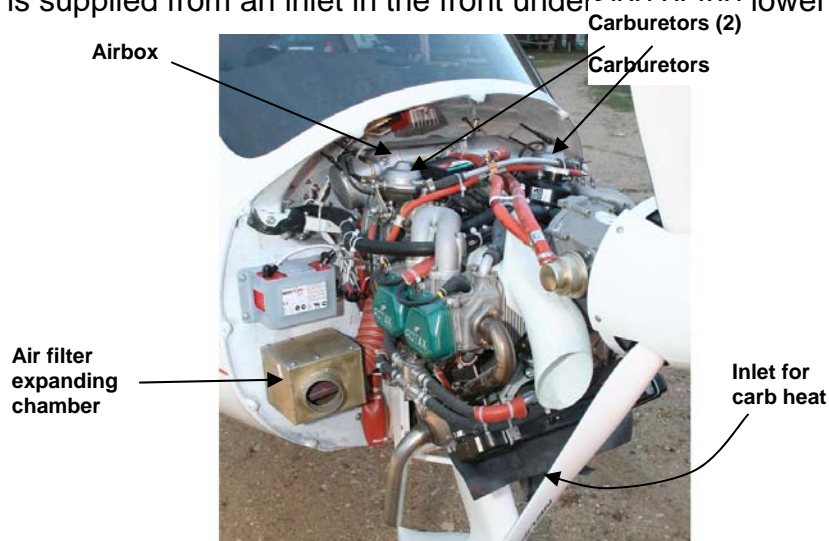

Warning: Since the supply ducts for fresh air and heated air are separate up to the air box, the engine can be easily supplied with alternate heated air should the air inlet become blocked in flight.

7.2.2. Propeller

The CTLS may be equipped with various propellers. The operating handbook and the maintenance manual of the relevant propeller published by the propeller manufacturer are delivered with the aircraft and must be studied in detail. The following propellers are certified for the CTLS:

Neuform	CR3-65-47-101.6 3 blade, composite propeller, adjustable
Neuform	CR3-V-R2H, 1.70m diameter, 3 blade, hydraulically activated variable pitch, composite propeller
Kaspar- Brändel	KA1, 1.60m diameter, 3 blade variable pitch, composite propeller
PowerFin	A R 65 T, 1.65 m diameter, 3 blade, composite propeller, ground adjustable

Warning: Depending on national regulations, in some countries (like USA) usage of variable pitch propellers is not allowed for LSA aircraft.

The adjustable propeller from Neuform is factory-set to prevent over-revving the engine during take-off, climb and level flight. Full throttle static engine speed on the ground will be roughly 4900 rpm. Engine speed of approx. 4800 - 4900 rpm is achieved during climb, whereas almost 5500 rpm are reached during level flight with full throttle, corresponding to maximum continuous engine speed. This pre-setting makes the monitoring of the correct propeller speed in flight very simple for the pilot.

Both variable-pitch propellers are controlled via a hydraulic adjustment mechanism. The lever is located in the central instrument panel, behind the power quadrant. The lever has several indexed positions. To set the propeller, the notch under the lever is released, the lever moved to the desired position and the notch locked in place. Via a hydraulic cylinder in the lever and the corresponding line, a hydraulic actuator in the engine compartment is activated. The actuator is located on the rear side of the gearbox, above the crankshaft. The propeller is adjusted via a control rod which runs through the hollow propeller shaft.

The variable-pitch propellers are factory-set so that engine speed at lowest pitch during take-off and initial climb does not exceed the maximum short-term permissible speed of 5800 rpm. The climb speeds given in the normal procedures section must be observed exactly. Should they be exceeded, there is a risk of the engine over-revving and being damaged.

Warning: If a variable-pitch propeller is not operated properly, the engine may over-rev. Propeller speed will increase constantly with increasing airspeed. For this reason, the variable-pitch propeller must already be adjusted to a higher pitch during climb. It is the responsibility of the pilot to ensure that engine operating limits are adhered to.

7.2.3. Fuel system

A fuel tank with a capacity of 65 l (17 gal) is integrated into each wing. The fuel tanks are each divided into two sections by an anti-sloshing rib. Fuel is filled into the outer section via a fuel filler opening on the upper side of each wing. To open the fuel filler cap, the lever in the cap must be raised and turned 90° anti-clockwise. The cap can then be removed. The cap is properly shut when the lever is pressed down into position.

Warning: The pilot must be certain during the preflight inspection that the fuel filler caps are properly shut. A missing cap leads to a massive loss of fuel in flight as the fuel is sucked out of the tank.

Fuel flows via a flapper valve into the inner section of the fuel tank inboard of the anti-sloshing rib. The flapper does not completely seal the inner tank. It does, however, greatly restrict the return flow of fuel into the outer chamber when one wing is low (sideslip). A sideslip can thus be undertaken even when low on fuel without risking fuel starvation to the engine.

The tanks are vented via coupled tubes in the outer tank sections, the air coming from NACA inlets on the outer side of each of the upper winglets. The vent tube is led through the tank in a loop along the upper wing skin along the main spar. In this way, the risk of fuel escaping into the vent tubes should the aircraft be parked with a wing low is minimised. As the vent tubes left and right are coupled, equal pressure prevails in both tanks even when the winglets experience different flow conditions.

Each tank outlet has a coarse screen which can be removed via a maintenance plate in the root rib for visual inspection and cleaning.

Fuel is fed by gravity via two fuel lines in the A columns. They have a large volume so that even with virtually empty tanks, enough fuel is available in a sideslip to ensure a engine power for landing. The two lines are connected to each other via a T-fitting. The fuel shutoff valve is located behind a second fuel filter and directly in front of the line through the fire wall. The fuel flow sensor is in this line to the engine compartment, on the cabin side of the firewall.

The fuel flows from there into the gascolator which finally has very fine filter. The gascolator is the lowest point in the fuel system and has a drain valve. The fuel system must be drained at this point before the first flight of the day and after filling up with fuel.

The fuel pump feeds fuel from the gascolator to the engine which then feeds the fuel to the carburetors. Excess fuel is pumped back to the gascolator.

The fuel system is presented schematically in the following diagram.

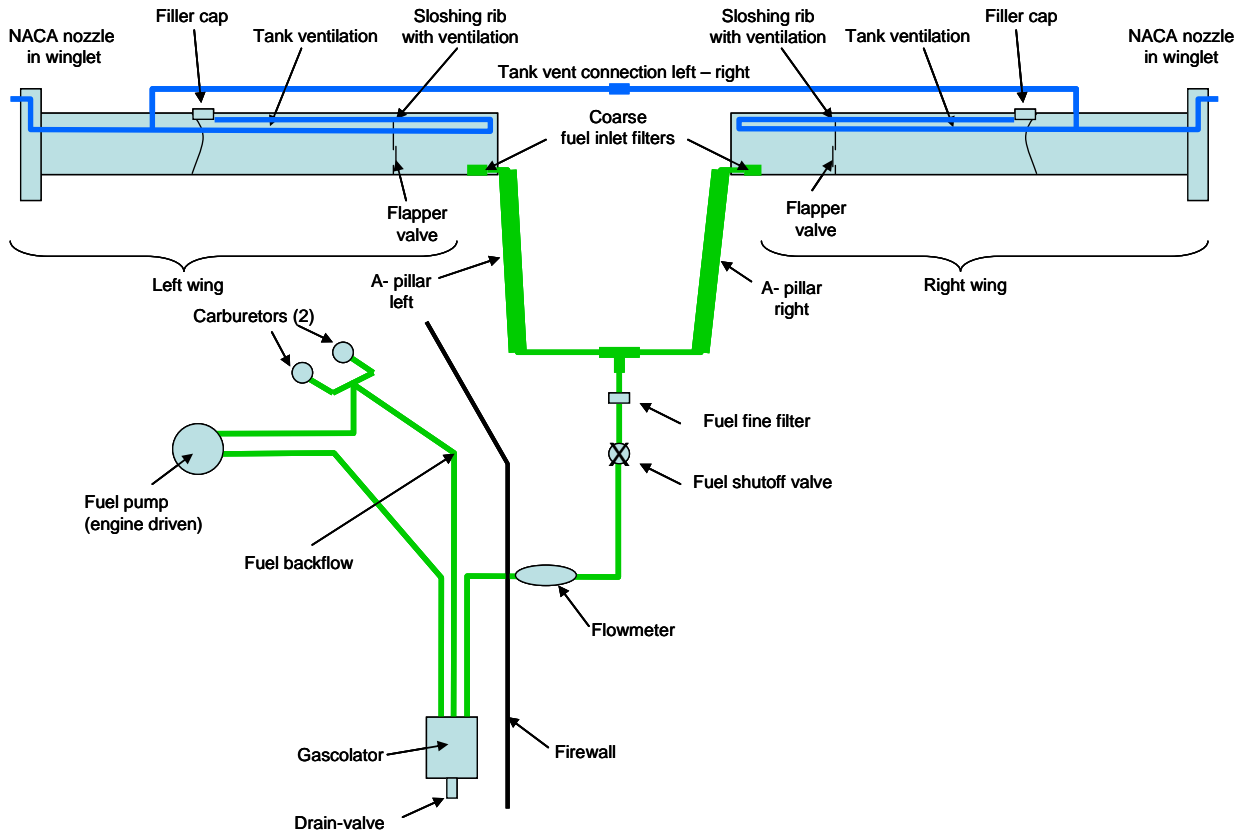

	Aircraft Operating Instructions (AOI)		
	Type: <i>CT</i>	Series: <i>CTLS LSA</i>	Page: 7-8

7.2.4. Electrical system

The design of the electrical system is based on the ASTM F2245 (design specifications for LSA) requirements for night flight. Only high-quality wiring is used, the cross-sections and insulation meet applicable aviation requirements.

The electrical system is based on a 12V, 7Ah lead-gel battery which is charged with a maximum output of 250 Watt by a DC alternator integrated into the engine compartment. This battery has very high performance and needs specific charging procedure if discharged. If properly maintained it has a very long service life.

Power is distributed via a common power bus which the fuses and circuit breakers of the individual instrument groups are directly connected. Power is then transferred to the instruments and avionics using switches where necessary. All ground lines are connected to the battery via a ground bus. The avionics are grounded separately from the rest of the aircraft in order to avoid interference.

The layout of the electrical system is depicted in the following block diagrams. They show the wiring layout and help to explain the function of the installation with respect to power supply as well as the data interchange between the individual instruments. Should more detailed schematic diagrams be required for maintenance purposes, these can be requested from Flight Design.

AF 043 00005	Revision No. 4	Date: 29 Apr 2008
--------------	----------------	-------------------

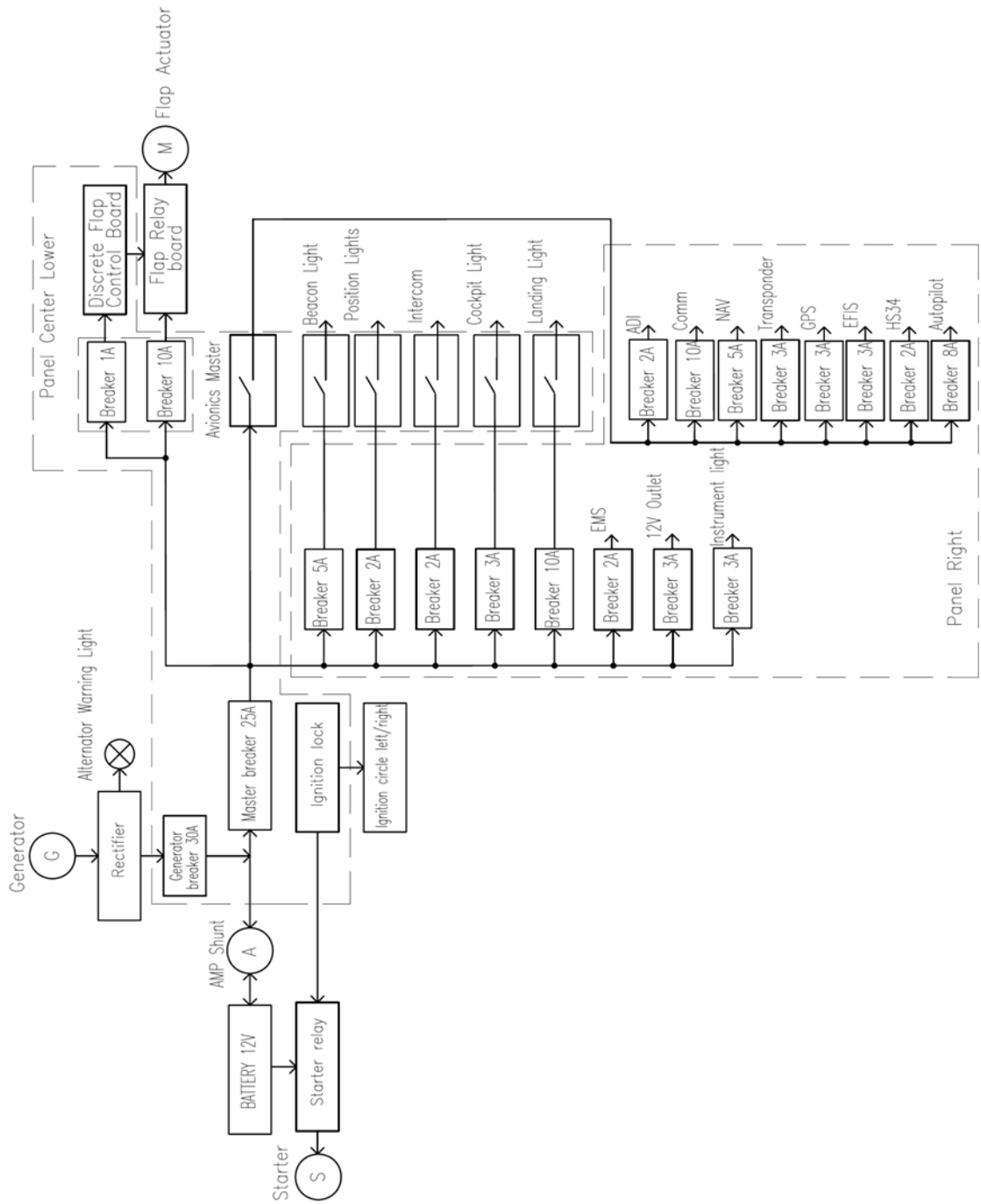

Block diagram - power supply

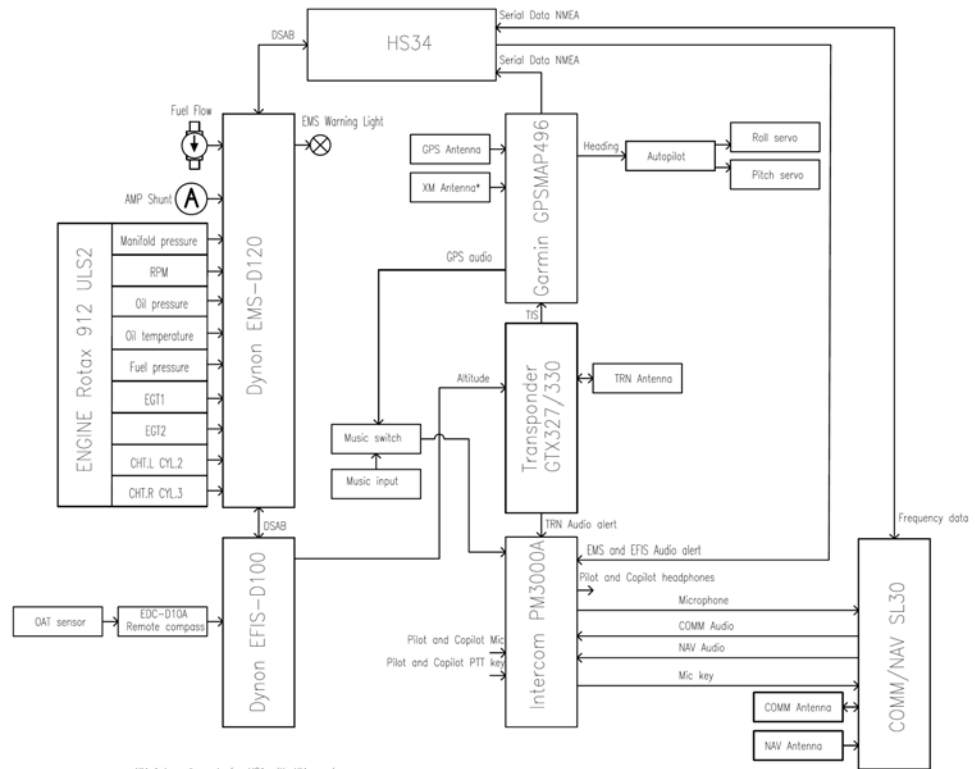

Block diagram - avionics installation without VOR / HS34

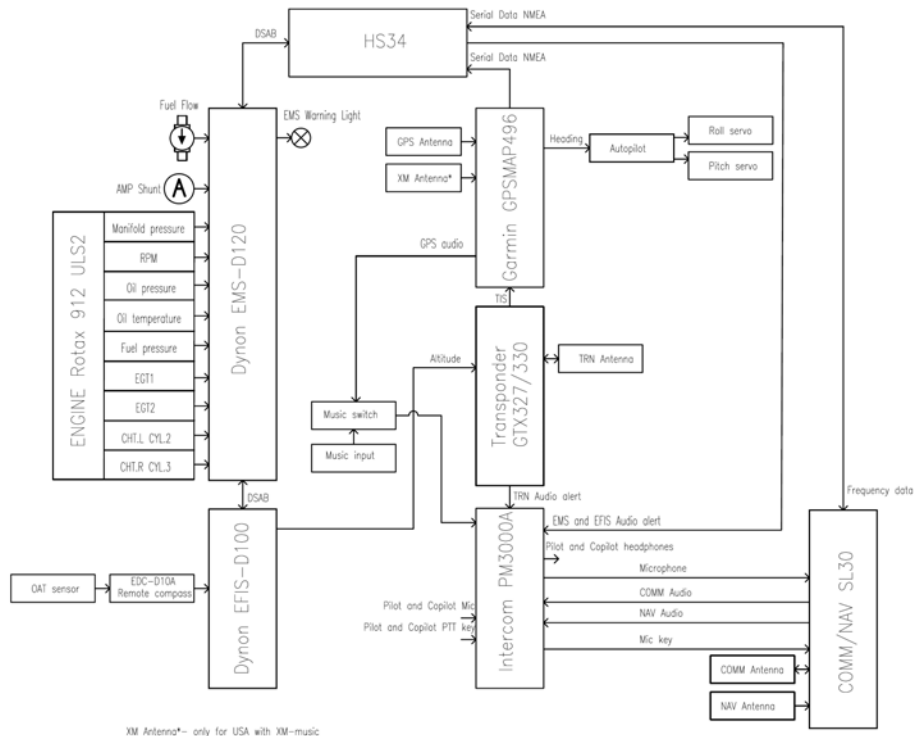

Block diagram - avionics installation with VOR / HS34

7.2.5. Landing gear and brakes

The main landing gear of the CTLS is made of composite materials and is of the cantilever spring type. The cantilever spring design ensures proper deflection behavior with good dampening.

The two separate gear legs (left / right) are mounted in a load bearing attachment in the fuselage. This attachment is in the fuselage main frame where the landing loads are introduced into the structure. The legs are attached to the structure by two bolts at the top ends. A clamp cushioned by a thin layer of rubber at the fuselage exit supports the gear leg. The fuselage exit is faired to an aerodynamically optimized form.

At the bottom of the landing gear strut there is a stub axle to which the main wheels and the brakes are attached. The main wheels have removable fairings.

The main wheels of the CTLS have hydraulic disc brakes which are activated via a centrally located lever in the cockpit. The brake lines are reinforced with fiber cloth and connections are crimped tightly on to the lines, thus ensuring high line rigidity and stability at a low installed weight. This also results in better brake efficiency.

By blocking the return line, the brakes can be locked for a parking brake function. The locking lever is in the middle console in the cockpit, directly behind the throttle quadrant. The parking brake can be locked before activating the brakes. The brakes can then be activated once through the check valve. The check valves keep the system under pressure, thus making single-hand operation of the parking brake simple.

Warning: This does not, however, mean that chocks are not needed when the aircraft is parked. Changes in temperature can cause a hydraulic brake system blocked in this way to lose pressure.

The nose gear strut is attached to the lower section of the large engine mount via journal bearings, making it steerable. The rotating section is a telescopic spring strut. Inside the strut, urethane inserts act as springs and dampeners, effectively preventing porpoising.

The nose wheel is steered via control rods which are attached directly to the pedals.

Warning: Should the aircraft no longer taxi straight, do not simply adjust the push-rods. Due to the special kinematics the tension of the rudder cables and thus the force gradient of the rudder will also be affected. Please contact a Flight Design service station.

The nose gear has an aerodynamically optimal composite fairing. This fairing can only be removed completely after the nose gear fork has been removed. This is, however, not necessary when the tire must be changed. It suffices to lift the fairing slightly. When remounting the fairing, ensure that it has threaded properly into the guide track at the top end of the fork (where the telescope is attached), the fairing could, otherwise, flutter and become damaged.

 FLIGHT DESIGN	Aircraft Operating Instructions (AOI)	
	Type: <i>CT</i>	Series: <i>CTLS LSA</i> Page: 7-12

7.3. Flight controls

7.3.1. Dual controls

The aircraft has dual controls, thus allowing operation from both seats. The dual controls cannot be separated.

Even although the aircraft can be flown from both seats, the pilot in command sits in the left seat. The arrangement of the instruments and operating devices is primarily optimized for this seat. Thanks to the dual controls, the aircraft is well equipped for training and instruction.

7.3.2. Rudder and nose wheel steering

The rudder is activated via control cables which are housed in a plastic sleeve in the tunnel on the fuselage floor.

The left and right foot pedals are coupled in the tunnel. The turnbuckle units to tension the cables and the connection to the nose wheel steering are in the front section of the tunnel.

Warning: We advise against making adjustments to the rudder steering. Due to the mechanical interlinking, this can adversely affect cable tension and/or wheel alignment. Please contact a Flight Design service station.



7.3.3. Stabilator

The CTLS has a drag-optimized stabilator with an anti-servo tab. It is attached to a fuselage-mounted stabilator pivot bearing. An individually matched counter-weight with which the stabilator is completely mass-balanced is also attached to this bearing.

The anti-servo tab on the trailing edge of the horizontal tail covers 75% of the stabilizer span. It is aerodynamically optimally attached to the fin by an elastic composite hinge. It is activated through a mechanical coupling when the stabilizer is deflected. In this way the anti-servo tab deflects in the opposite direction as the stabilator, thus improving stabilator effectiveness and generating a proper force gradient on the control stick.

Warning: When dismantled or when the controls are disconnected, the anti-servo tab must never be pushed beyond normal operating limits as this causes damage to the elastic hinge. We recommend that the trim tab be clamped with an edge guard or taped to the outside edges to prevent inadvertent movement.

The stabilizer is activated via a special push-pull cable that runs through the tunnel and along the fuselage floor. This push-pull cable aligns itself to the fuselage and is maintenance-free.

7.3.4. Stabilizer trim

Stabilizer trim is adjusted via the trim wheel adjacent to the throttle. The trim indicator is located directly adjacent to the wheel. The aircraft becomes nose heavy when the wheel is rotated forward and tail heavy when it is turned backward.

Via a Bowden cable, the trim wheel activates a threaded spindle at the stabilator pivot bearing. This spindle is self-locking and adjusts the zero position of the anti-servo tab. Since the anti-tab has a large span, the required deflection is not very big.

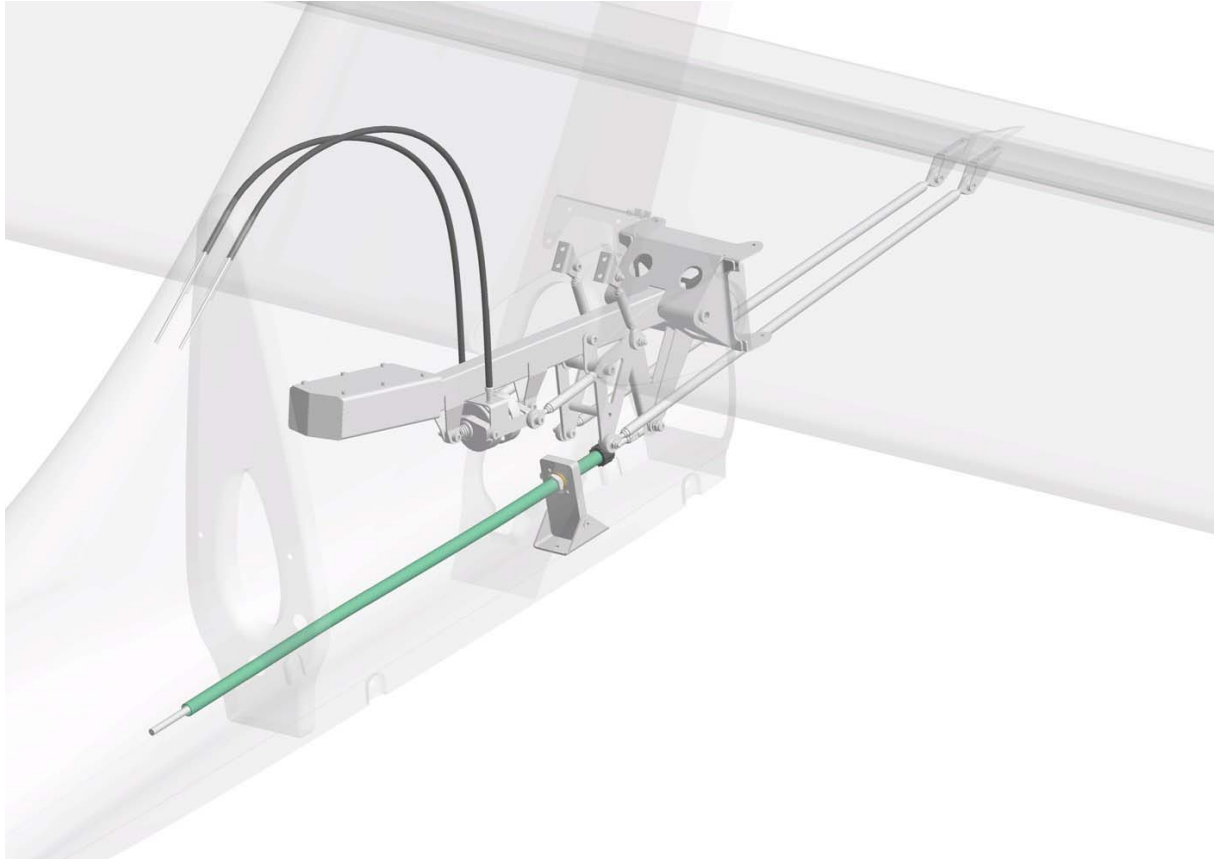

7.3.5. Ailerons

The ailerons are activated via push rods which run from the control stick through the tunnel to the mixer in the baggage compartment behind the main frame. In the mixer the ailerons are coupled with the flap controls as the ailerons are deflected when the flaps are set.

Control rods run from the mixer upwards behind the main bulkhead where the associated bell cranks on the wing root rib are activated via a torsion shaft and a connecting rod.

The following diagram depicts the aileron controls (orange) and flap controls (turquoise) in the fuselage with mixer and with connection to the wings.

The aileron controls have return springs which ensure more harmonic force gradients. These springs are attached to the rear of the main bulkhead and engage in the mixer.

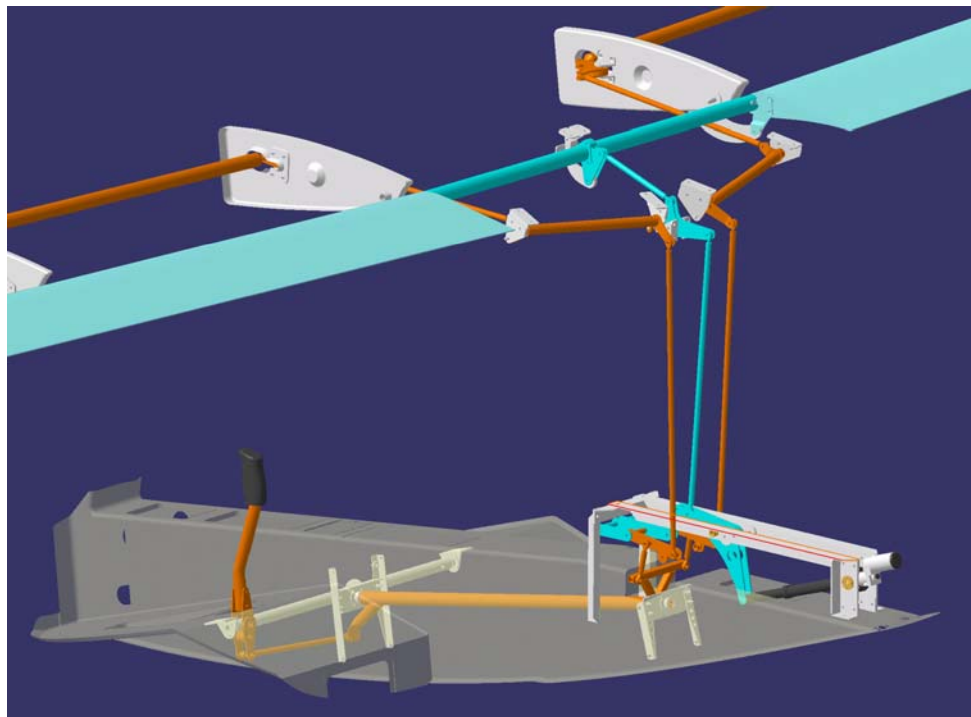

7.3.6. Aileron trim

Aileron trim is activated by a trim wheel in the middle of the tunnel between the pilot and co-pilot. By turning the trim wheel to the right, the aircraft will bank to the right - by turning it to the left, the aircraft will bank to the left. Aileron trim influences the return springs in the aileron controls. Due to trim kinematics, it is usual that trimming in one direction is tauter than in the other direction as it changes the tension of one of the two springs.



7.3.7. Wing flaps

The flaps are driven by a geared electric motor and are activated via the flap control in the lower section of the instrument panel. The desired flap setting is selected with a lever switch. The position indicator will flash as long as the flaps are moving to the desired setting. Once the desired setting has been reached, the position will be constantly illuminated. The flaps may be set at any of the following positions:
- 6°, +0°, +15°, +30°, +35°.

The flap motor is integrated into the mixer behind the main bulkhead in the aircraft baggage compartment. As it acts on the controls mixer, the flaps are activated via push rods. Both flaps are directly attached to a torque tube in the fuselage, thus ensuring that they are always deflected symmetrically.

Warning: An individual maximum airspeed is defined for each wing flap setting. The pilot must observe these to ensure that the aircraft and the flight controls are not over-stressed.

The flap servo has an internal load-limiting device which prevents the extension of the flaps at too high airspeeds without causing sustainable damage to the structure. Should the indicator blink constantly when extending the flaps, airspeed should be reduced. If the flaps then extend, the internal load-limiting device was in operation. If extension speed is below the maximum speed for flap extension as given in the handbook, the flap system may be out of adjustment. The nearest Flight Design service station should be contacted.

The flap control dual circuit breaker is to be found directly adjacent to the flap controls. It will pop if the flap servo is continuously over-loaded. As it is a thermal circuit breaker, it can take some time before it can be pushed back in. We emphasize once again that the CTLS can be flown and landed safely in any flap position. Refer to Chapter 3 - Emergency Procedures.

7.3.8. Rudder trim

Rudder trim is activated via the trim wheel on the top of the tunnel near the aileron trim. In front of the recovery system release lever. Turning the trim wheel to the right steers the aircraft nose to the right - turning the wheel to the left steers the aircraft nose to the left. The rudder trim is attached directly to the rudder cables.

7.3.9. Ballistic recovery system

The CTLS LSA is always delivered with a ballistic recovery system. Deployment of the recovery system is described in detail in Chapter 3 - Emergency Procedures.

Warning: The recovery system is a very important safety element of this aircraft. Even assuming that the recovery system will never be used, it is absolutely essential that the pilot regularly familiarizes him/herself with the deployment of the system and the simple actions involved. It also pays off to watch the videos showing successful deployment of the parachute which the recovery system manufacturer has posted on its website. Some of the videos show real-life deployment filmed from the cockpit and illustrate well just how useful this system can be in doubtful situations.

The ballistic recovery system comprises a recovery parachute and a ballistic rocket which are located in the upper baggage compartment above the controls mixer behind the main bulkhead. The rocket is activated via a pull cable attached to the deployment handle on the upper side of the tunnel in the cockpit.



The parachute egress hatch is on the upper side of the fuselage, directly above the recovery system. The opening is covered by a light flap which easily lifts off when the system is deployed. The installations design effectiveness has been repeatedly confirmed through ejection tests.

After deployment of the recovery system, the aircraft is suspended by four main belts. Two front belts are connected to the big engine frame, directly next to its attachment points to the engine firewall at the A-pillar root. The two rear belts are attached to hard points close to the main landing gear support on the main bulkhead. With this attachment the aircraft is suspended with approximately 13° nose down pitch under the parachute. In this stable position, the aircraft will come down nose

wheel and engine / engine mount first. Deformation of the metal structure will absorb much of the impact energy before the airframe itself is affected.

In non-deployed condition the belts are covered by the fuselage roof and stored behind the main bulkhead. When deployed, typically the opening forces are strong enough to pull these belts through the roof. In very rare cases (extreme low aircraft weight and at stall speed) it might happen that the belts do not tear open the aircraft roof. In this case the aircraft will come down with little more pitch down, and the rear belt not tightened. Experience from a real CT ejection has shown this is a proper descent position.

The following picture shows the installation of the two variants of recovery systems used in the aircraft. The next illustration (not to scale!) shows the aircraft position suspended under the parachute.

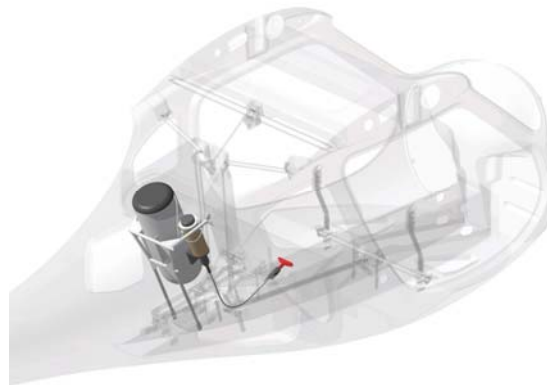

Installation of BRS rescue system (in container)



Installation of Junkers Magnum rescue system (Softpack)



Aircraft Operating Instructions (AOI)

Type: *CT*

Series: *CTLS* LSA

Page: 7-19

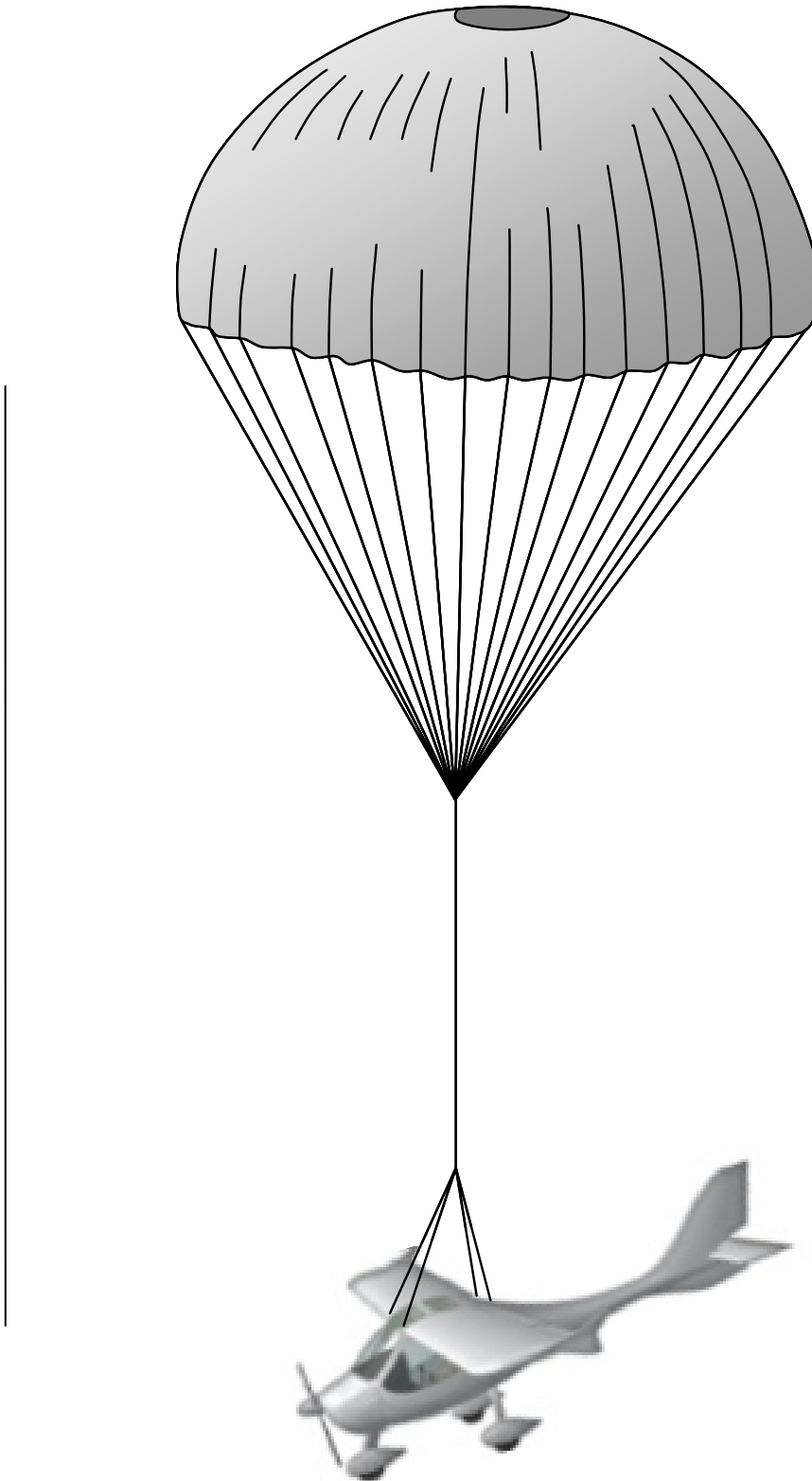



7.4. Cockpit

7.4.1. Instrument panel

The instrument panel for the CTLS is available in various layouts. The large mushroom-shaped panel is usually standard. It has four sections - upper left, upper center, upper right and lower. The flight instruments are located in the three upper panels whereas the lower panel contains aircraft controls, the switches panel and the intercom.

Standardized numbering of equipment based on the table below is used for the diagrams on the following pages.

1	EFIS, Dynon 100 electronic flight information system
2	EMS, Dynon 120 engine monitoring system
3	Autopilot CT Pilot 1 axis / 2 axis / 2 axis w/ vertical speed control
4	Back up airspeed indicator D 57 mm (2-1/4")
5	not used
6	Back up altimeter D 57 mm (2-1/4")
7	not used
8	not used
9	Slip indicator
10	not used
11	Hobbs hour meter
12	Alarm light, alternator
13	Alarm light, electronic engine monitoring
14	Comm radio, Garmin SL40
15	Nav/Comm, Garmin SL30
16	Transponder, GTX 328 (Mode A/C) oder GTX 330 (Mode S)
17	GPS, Garmin 496
18	Dynon HS34 input system for GPS & VOR for the EFIS

7.4.2. Upper panel

Panel with Glass cockpit, without NAV radio:



Panel with Glass Cockpit, with NAV radio:



7.4.3. Circuit Breakers

All circuit breakers – except the circuit breaker for the flap controller, which is located directly next to the flap controller – are located in the lower part of the upper right panel. Depending from the actual aircraft equipment these are installed. The following illustration shows the order of the circuit breakers.

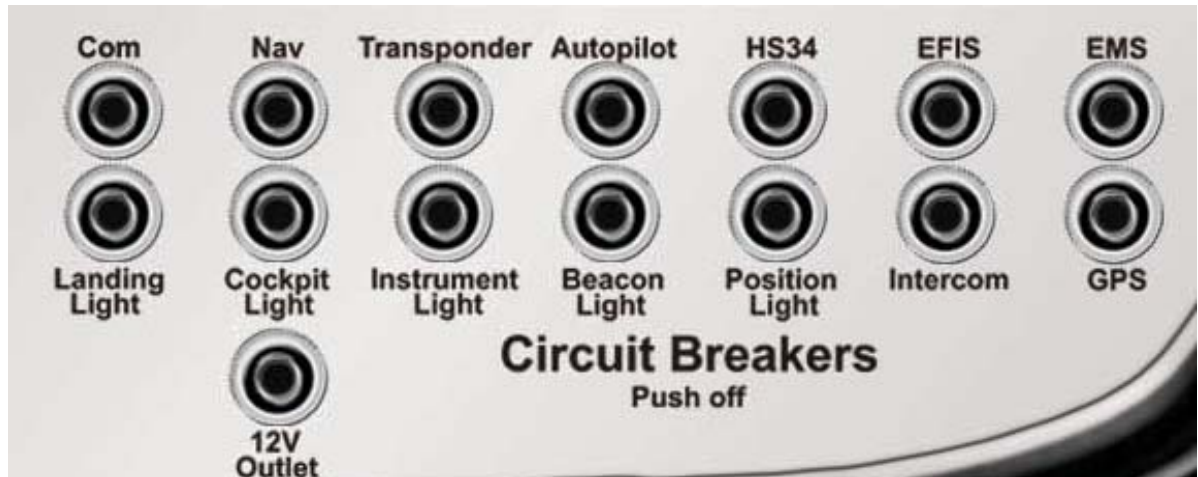

7.4.4. Lower panel

The equipment in the lower panel varies only slightly. If no avionics are installed, there is no intercom. Otherwise, the controls and switches are always configured as shown below.



7.4.5. Throttle quadrant

The throttle quadrant is located in the middle console/tunnel, in front of the lower instrument panel. It can be easily operated from both seats, although it is primarily designed to be operated from the left seat, by the pilot-in-command.

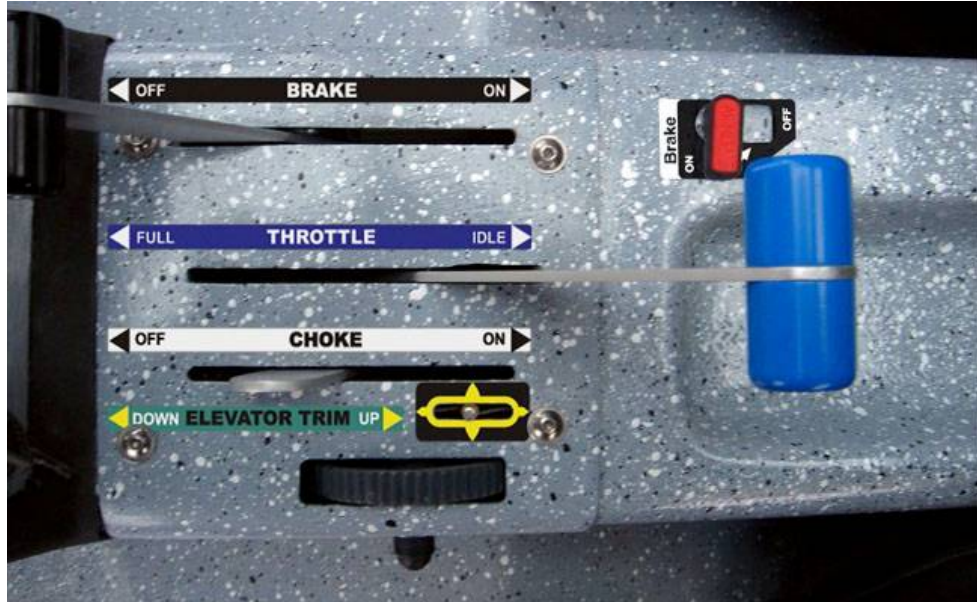

7.4.6. Carbon monoxide detector

Every CTLS aircraft (starting S/N: 07-11-15) is equipped with Carbon Monoxide (CO) Detector.

The owner (pilot) is responsible to watch the date on the detector and when necessary – replace it. The owner (pilot) is also responsible to mark the date when install the new one.

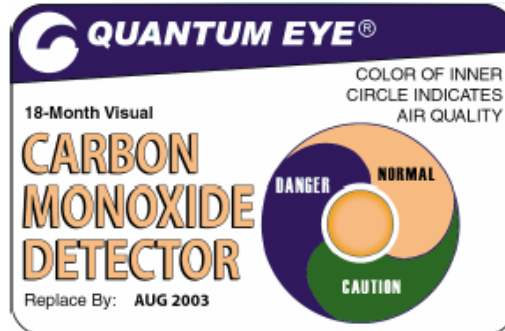

Condition – Color: Normal – Yellow, Caution – Green, Danger – Dark Blue.

The Quantum Eye is a multi-level Carbon Monoxide Detector. It provides a visual indication of carbon monoxide contamination. Each detector is packaged in a protective bag that when opened activates it. Once activated the minimum product lifetime is 18 months.

Adhesive backing allows it to be easily mounted in the cockpit or any clearly visible surface.



Operating temperature range is from 41° to 100 ° F (5° C to 38° C), relative humidity (RH) range from 25 to 90% RH.

Sensor Regeneration: from caution – 2 hours, from danger – 6 hours.

Note: This information is for examination only. For details please refer to the manufacturer website www.QGinc.com.



Aircraft Operating Instructions (AOI)







Type: *CT*

Series: *CTLS* LSA

Page: 7-26

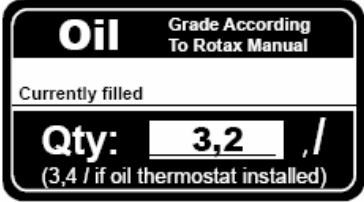
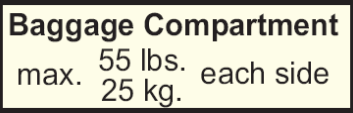
7.5. Placards and markings

	Item	Location												
White arc	39 – 62 kts (72 – 115 km/h)	airspeed indicator												
Green arc	44 – 120 kts (81 – 222 km/h)	airspeed indicator flap's -6°												
Yellow arc BRS 1350	120 – 145 kts (222 – 269 km/h)	airspeed indicator												
Red line	145 kts (269 km/h)	airspeed indicator												
Red line tach	5800 rpm	rpm indicator												
Red line	102 psi (5 bar)	oil pressure indicator												
Red line	266 F (130°C)	oil temperature indicator												
Red line	248 F (120°C)	water temperature indicator												
Metal identification plate	<div style="border: 1px solid black; padding: 5px; text-align: center;"> Aircraft Type CTLS Flight Design GmbH s/n 07-11-12 Date Manufactured 16.Oct.07 </div>	on the airframe inside the engine compartment or the left side rear fuselage near the stabilator												
Calibration card	after calibration	below the compass												
Warnings and load limits	<div style="border: 1px solid black; padding: 5px;"> <p style="text-align: center; color: red; margin: 0;">Warnings:</p> <p style="text-align: center; margin: 0;">Do not remove safety belts in flight</p> <table style="width: 100%; border-collapse: collapse;"> <tr> <td style="border: 1px solid black; padding: 2px;">Read manuals before flight</td> <td style="padding: 2px;">max takeoff weight kg</td> </tr> <tr> <td></td> <td style="padding: 2px;">max cabin load kg</td> </tr> <tr> <td></td> <td style="padding: 2px;">max cabin load at full fuel kg</td> </tr> </table> </div>	Read manuals before flight	max takeoff weight kg		max cabin load kg		max cabin load at full fuel kg	upper half central instrument panel						
Read manuals before flight	max takeoff weight kg													
	max cabin load kg													
	max cabin load at full fuel kg													
Warnings	<div style="border: 1px solid black; padding: 5px; text-align: center;"> <p style="color: red; margin: 0;">WARNINGS:</p> <p style="margin: 0;">Manoeuvre speed 98 kt / 184 km/h IAS</p> <p style="margin: 0;">No intentional spins</p> <p style="margin: 0;">Aerobatics prohibited</p> </div>	left instrument panel												
Take-off checklist summary		left instrument panel												
<div style="border: 1px solid black; padding: 5px;"> <p style="text-align: center; margin: 0;">Takeoff Checklist Summary</p> <table style="width: 100%; border-collapse: collapse;"> <tr> <td style="border: 1px solid black; padding: 2px;">Pre-flight Checklist..... confirm complete</td> <td style="border: 1px solid black; padding: 2px;">Fuel Quantityconfirm checked</td> <td style="border: 1px solid black; padding: 2px;">Choke, Carb Heatconfirm off</td> </tr> <tr> <td style="border: 1px solid black; padding: 2px;">All Doors confirm closed</td> <td style="border: 1px solid black; padding: 2px;">Fuel Valveconfirm open</td> <td style="border: 1px solid black; padding: 2px;">Flight Controlsconfirm checked</td> </tr> <tr> <td style="border: 1px solid black; padding: 2px;">Safety Beltsconfirm fastened</td> <td style="border: 1px solid black; padding: 2px;">Before Takeoff Checklist ...confirm complete</td> <td style="border: 1px solid black; padding: 2px;">Flaps confirm set</td> </tr> <tr> <td></td> <td style="border: 1px solid black; padding: 2px;">Pitch Trimcobfirm neutral</td> <td style="border: 1px solid black; padding: 2px;">Parachuteconfirm armed</td> </tr> </table> <p style="text-align: center; color: red; margin: 5px 0 0 0;">Warning: Checklist summary only. Complete checklists by manual are mandatory!</p> </div>			Pre-flight Checklist..... confirm complete	Fuel Quantityconfirm checked	Choke, Carb Heatconfirm off	All Doors confirm closed	Fuel Valveconfirm open	Flight Controlsconfirm checked	Safety Beltsconfirm fastened	Before Takeoff Checklist ...confirm complete	Flaps confirm set		Pitch Trimcobfirm neutral	Parachuteconfirm armed
Pre-flight Checklist..... confirm complete	Fuel Quantityconfirm checked	Choke, Carb Heatconfirm off												
All Doors confirm closed	Fuel Valveconfirm open	Flight Controlsconfirm checked												
Safety Beltsconfirm fastened	Before Takeoff Checklist ...confirm complete	Flaps confirm set												
	Pitch Trimcobfirm neutral	Parachuteconfirm armed												
Warning	avionics off before engine start or stop	Instrument panel, low center												
Fuel grade	<div style="border: 1px solid black; padding: 5px; text-align: center;"> <p style="margin: 0;">Fuel</p> <p style="margin: 0;">MINIMUM 91 Octane Auto Fuel or 100 LL AvGas</p> <hr style="border: 0; border-top: 1px solid black; margin: 5px 0;"/> <p style="margin: 0;">17 Gallons Per Side (16.5 Useable)</p> </div>	adjacent to each fuel tank filler cap												
<div style="border: 1px solid black; padding: 5px; background-color: #000080; color: white;"> ◀ Full Throttle Idle ▶ </div>		adjacent to throttle												
<div style="border: 1px solid black; padding: 5px; background-color: #cccccc;"> ◀ Off Choke On ▶ </div>		adjacent to choke												

		adjacent to trim wheel
		adjacent to brake lever
Flap position	-6°, 0°, 15°, 30°, 35°	flap selection lever
Oil grade and amount		inspection flap engine cowling
Circuit breakers	Main circuit breakers according to function	instrument panel
Master switch	Batt	instrument panel
Alternator switch	Gen	instrument panel
Packing interval	according to recovery system handbook	recovery system handbook and on recovery system
Baggage payload		Posted on both sides of the baggage compartment
Baggage payload, hat rack		Posted on both sides of the hat rack, at the back
Warning		Posted on all sides of the baggage compartment
Door opening instructions		Posted on the outside of each door
		Posted on the inside of each door handle
Warning	„Danger“	Parachute recovery system hatch
Warning	Recovery system, only in an emergency! 1.) switch off engine 2.) deploy recovery system 3.) protect yourself	Posted near the actuation handle for the parachute recovery system
Warning	Observe towing speed	Posted near the airspeed indicator if tow hook installed

8. HANDLING, SERVICE, MAINTENANCE

Warning: Attention must be paid to the proper securing of the recovery system during any servicing or repair work to ensure that it is not inadvertently activated (ensure that the activation handle is secured with the safety pin inserted).

8.1. Jacking

There are several ways of jacking the aircraft. However, it must always be secured against inadvertent rolling by applying the parking brake and positioning chocks under the wheels which are on the ground.

The wheel fairing must be removed before work can be started on a main wheel. The aircraft can then be lifted off the ground on the appropriate side. A helper holds the aircraft in the area of the tie-down points on the wing under the spar (= exactly at the tie-down point) and lifts the wing slightly. As soon as the wheel is free, a chock or jack is placed under the lower end of the landing gear strut. The wheel can now be removed.

When work must be carried out on the nose wheel, the aircraft remains standing on the main wheels. Using the tail tie-down belt and ballast (e.g. a jerry-can filled with water), the tail is held down until the nose wheel is free. Alternatively, the aircraft can be jacked exactly under the firewall bulkhead, making sure that the fuselage is adequately cushioned.

When a requirement exists to jack the entire aircraft off the ground, this can be done as described above using the jack point on the firewall bulkhead. It can also be jacked at the main bulkhead, exactly between the main landing gear struts using a soft, wide support. In this case, both wings must also be supported to keep the plane level.

Warning: Particular care should be taken if the entire aircraft has to be jacked off the ground. The fuselage is a delicate, light-weight composite sandwich structure. The jacking load must, therefore, be distributed over a large area. In addition, there is also the risk of the fuselage starting to roll on the jacks when the aircraft is raised completely off the ground.



Aircraft Operating Instructions (AOI)

Type: *CT*

Series: *CTLS LSA*

Page: 8-2

8.2. Securing the aircraft for road transportation

Road transport is only allowed by qualified mechanics. Necessary procedures for assembly and disassembly are given in the separate CTLS LSA maintenance manual.

8.3. Parachute recovery system maintenance

The parachute recovery system requires no maintenance, except observance of the pack intervals for the parachute and the exchange intervals for the rocket. These intervals are recorded in the recovery system handbook.

The recovery system should only be removed from the aircraft by an authorized workshop. Depending upon national regulations, special approval may be required to handle the recovery system rocket.



8.4. Cleaning and care

A modern aircraft made of composite materials must be cleaned with caution. Numerous cleaning agents have been developed especially for certain materials and can indeed cause damage to others. Using the wrong cleaning agent can damage your aircraft or parts of it. This damage may be visible or not directly detectable. Damage can take the form of simple flaws or can impair the structure. It is thus essential that you check the ingredients of a cleaning agent before use. If in doubt, contact your local Flight Design service station.

Warning: High-pressure washer equipment should never be used to clean the aircraft!

8.4.1. Airframe

Many components of composite aircraft are sandwich constructions comprising a foam core and layers of glass fiber, carbon fiber or aramid fiber. The CTLS is made from a carbon or aramid sandwich and is painted with a two-component polyurethane paint.

The Rohacell foam core used for the wings was chosen for its fuel durability. However, Rohacell is not resistant to alkaline liquids. For this reason, no alkaline cleaning agents such as Fantastic, Formula 409, Carbonex or Castrol Super Clean should be used. These alkaline cleaning agents can cause the Rohacell foam core to disintegrate if they penetrate to the core. A rippled surface is an indication of such disintegration. Components damaged in this way cannot be repaired and have to be replaced.

The wing spars of the CTLS cannot be damaged in this way.

Products from the ComposiClean series which has been specially developed for aircraft made of composite materials are approved as cleaning agents. Each CTLS leaves the factory with a basic set of this cleaning agent series.

8.4.2. Windshield and windows

The windshield and windows of the CTLS are made of perspex (plexiglass, acrylic glass) which was formed at high temperatures. Although perspex is very robust, it must be cleaned with care to ensure that it is not scratched. Never use abrasive cleaning agents or dirty cloths. Usually the windshield and windows can be cleaned using lots of clean water. However, if dirt is stubborn, perspex cleaning agents only should be used.

Only use special perspex polish for the windshield and windows. Never polish in a circular movement, always in straight lines (up and down or from side to side). This prevents the occurrence of the disturbing halo effect caused by circular scratches. Light scratching can usually be polished out by your Flight Design service station.

Make sure that you never leave solvent-soaked cleaning cloths under the windshield or near the windows. Vapors can quickly lead to small stress cracks in the glass. A windshield or windows damaged in this way cannot be repaired and must be replaced.



Aircraft Operating Instructions (AOI)

Type: *CT*

Series: *CTLS LSA*

Page: 8-4

8.4.3. Power plant

The Rotax 912 operating handbook recommends the use of a standard degreaser. Please follow the instructions given in the operating handbook and make sure that the degreaser does not come in contact with the airframe.

Warning: If a moisture-based cleaning agent is used on the engine, the electronics must be protected from getting damp. High-pressure cleaning devices should never be used to clean the engine.

	Aircraft Operating Instructions (AOI)		
	Type: <i>CT</i>	Series: <i>CTLS LSA</i>	Page: 8-5

8.5. Mandatory aircraft inspections

The following inspections are a minimum requirement for the maintenance of the aircraft:

25 h inspection (engine only)

It is carried out only once on new aircraft after they have clocked the first 25 hours of operation. It must also be carried out 25 hours after a major overhaul.

100 h inspection (or annual)

This inspection must be carried out at least once a year even if the aircraft is not operated for 100 hours during the calendar year. The interval to the next inspection starts with this advanced inspection.

200 h inspection

The same as the 100 h inspection, this inspection can be brought forward when fewer hours have been flown. It is performed at every other 100 h inspection.

The TBO times for the engine and propeller must also be observed. Provision is made for these items in the 100 h and 200 h inspection lists.

The current maintenance list as required by the engine manufacturer is mandatory for engine maintenance. The inspection items listed here only give a general indication of the condition of the installation as a whole, not of the engine itself.

These inspections do not supersede any mandatory airworthiness inspections required by the national aviation authority of the country in which the aircraft is registered.

The record of the inspections must be documented. A copy of following list in which the points are ticked off or appropriate notes should be kept as a record.

The detailed maintenance procedures for the CTLS LSA version are described in a separate maintenance manual. The CTLS is a modern and somewhat complex machine which requires specific training for proper maintenance. We, therefore recommend that the 100 h inspections be carried out at Flight Design approved repair station if possible. Besides that for all maintenance steps the minimum qualification requirements for the repairman are defined.

AF 043 00005	Revision No. 4	Date: 29 Apr 2008
--------------	----------------	-------------------

8.6. Repairs to the airframe

Warning: Minor repairs on non-lifting parts may only be carried out by qualified personnel approved by the manufacturer.

Warning: Major repairs, particularly after accidents, may only be carried out by the manufacturer or by a Flight Design authorized aviation workshop.

Original materials only should be used for repair work. Should you discover structural damage, please contact a Flight Design service station or a workshop qualified to undertake such repair work. Should this not be possible, please contact Flight Design at the valid service mail address listed on the website. Based on your description of the damage, we shall make recommendations as to what you should do. You will also receive precise repair instructions and documents showing exact structural details for the part of the aircraft affected.

8.6.1. Lubricants and operating fluids

Brake fluid
Coolant

Aeroshell Fluid 41 MIL-H-5606 Brake Fluid
Glysantine/water mixture (50 : 50) in accordance with the instructions in the engine operating handbook.

Warning: Anti-freeze from different manufacturers must not be mixed as they may react with each other and flocculate. If in doubt, the mixture should be completely drained off and replaced. Flight Design uses BASF Protect Plus, as recommended by Rotax. If the anti-freeze is changed, an aluminum-compatible anti-freeze recommended by Rotax should be used.

Warning: Flight Design advises against the use of Evans coolant. The advantages offered by this fluid are negated by sustained operational problems (e.g. moisture absorption). Based on the results of testing under various climatic conditions, it has been demonstrated that Evans is not necessary for the safe operation of the CTLS.

Engine oil
Fuel

in accordance with the Rotax manual
EN 228 Super or Super Plus
91 AKTI (octane) premium unleaded auto
AVGAS 100 LL

Warning: Not every oil type is suited to engine operation with AVGAS or MOGAS. Refer to the relevant version of the Rotax engine manual for detailed information on suitable oil types. The list of suitable engine oils is constantly adjusted according to availability. It is, therefore, recommended you consult the current list on the Rotax Service Bulletins website.

Hydraulic fluid, variable pitch propeller
Lubricant, wing bolts
Lubricant, bearings, rod ends

DOT 4 SAE J1703 /FMVSS 116
Heavy duty grease WGF 130 DIN 51502
Heavy duty grease WGF 130 DIN 51502

	Aircraft Operating Instructions (AOI)	
	Type: <i>CT</i>	Series: <i>CTLS LSA</i> Page: 8-7

Warning: The plastic bearings on the flaps and the ailerons are maintenance-free and should not be greased.

8.7. Control surface deflections

The settings of the control surfaces and the wing flaps greatly influence aircraft characteristics. The correct surface deflections are defined within the Aircraft Maintenance Manual.

The aileron-flap mixer system is highly sensitive to adjustments in the control elements. Modifying the adjustment of a bellcrank may change the mixing function. All adjustments to the control system must be done according to Flight Design specifications. We therefore recommend strongly that this type of work only be done by Flight Design approved service stations.

AF 043 00005	Revision No. 4	Date: 29 Apr 2008
--------------	----------------	-------------------



Aircraft Operating Instructions (AOI)

Type: *CT*

Series: *CTLS LSA*

Page: 9-1

9. SAILPLANE TOW

A towing hook intended to tow sailplanes may be already factory installed to the aircraft. Flight testing of sailplane towing according to the standards is not yet concluded. Towing of gliders is therefore not permitted.

Warning: Even when the towing hook is already installed to the aircraft, towing of sailplanes is not permitted with the CTLS LSA.

Your local Flight Design Dealer can inform you when the system is ready tested and released for use. This requires replacement of this chapter of the AOI against the released version containing all operation limitations and procedures for the explicit aircraft through Flight Design, and may require updates to the installed towing system.



Aircraft Operating Instructions (AOI)

Type: *CT*

Series: *CTLS LSA*

Page: 10-1

10. BANNER TOW

A towing hook intended to tow banners may be already factory installed to the aircraft. Flight testing of banner towing according to the standards is not yet concluded. Towing of banners is therefore not permitted.

Warning: Even when the towing hook is already installed to the aircraft, towing of banners is not permitted with the CTLS LSA.

Your local Flight Design Dealer can inform you when the system is ready tested and released for use. This requires replacement of this chapter of the AOI against the released version containing all operation limitations and procedures for the explicit aircraft through Flight Design, and may require updates to the installed towing system.

 FLIGHT DESIGN	Aircraft Operating Instructions (AOI)		
	Type: <i>CT</i>	Series: <i>CTLS LSA</i>	Page: 11-1

11. APPENDICES

11.1. CURRENT WEIGHING REPORT

The current weighing report should be inserted here. Old weighing reports should be kept so that the history of the aircraft is properly documented. They should be marked by hand with the word "INVALID". The owner of the aircraft is responsible for ensuring that a valid weighing report is made available.

AF 043 00005	Revision No. 4	Date: 29 Apr 2008
--------------	----------------	-------------------

 FLIGHT DESIGN	Aircraft Operating Instructions (AOI)		
	Type: <i>CT</i>	Series: <i>CTLS LSA</i>	Page: 11-2

11.2. CURRENT EQUIPMENT LIST

The current equipment list should be inserted here. Old equipment lists should be kept so that the history of the aircraft is properly documented. They should be marked by hand with the word "INVALID". The owner of the aircraft is responsible for ensuring that a valid equipment list is available.

AF 043 00005	Revision No. 4	Date: 29 Apr 2008
--------------	----------------	-------------------

